

## Relief Valves

### *Index*

500 Series	1
L500 Series	7
HP500 Series	9
5100 Series	11
D500/M5100 Series	17
5300 Series	21
R6000 Series	25



*relief valves*

## 500 Series

*Adjustable Popoff & Inline Relief Valves  
0.5 to 150 psig (10 bar)*

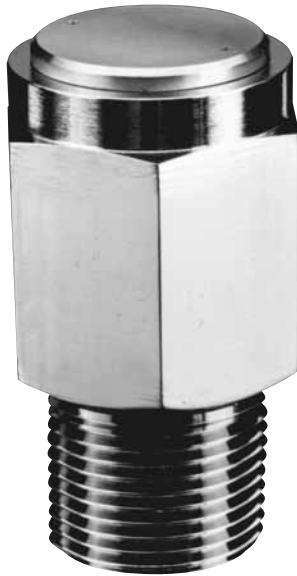

### Features

- Popoff or inline valves
- Adjustable cracking pressure
- Zero leakage
- Optional factory preset
- Accurate set pressure
- Wide range of cracking pressure
- Tamper-proof adjustment
- 100% seat leakage tested
- PED certifications and CE marking available for most models

### Applications

- System overpressure protection
- Storage tanks
- Freon® recovery systems
- Medical equipment
- Refrigeration & heating equipment
- Measuring & dispensing pumps
- Communications equipment
- Process control instruments
- R & D pilot plants
- Vacuum pump safety

### Technical Data

<b>Body Construction Materials</b>	Aluminum, brass, 303 or 316 stainless steel
<b>O-ring Materials</b>	Buna N, ethylene propylene, neoprene, silicone, PTFE, or Viton®
<b>Spring Materials</b>	302 stainless steel or 17-7 PH stainless steel
<b>Operating Pressure</b>	Vacuum to 200 psig (14 bar)
<b>Inline Valve Proof Pressure</b>	400 psig (28 bar)
<b>Inline Valve Burst Pressure</b>	Above 500 psig (34 bar)
<b>Temperature Range</b>	-320° F to +400° F (-196° C to +204° F) <i>Based on o-ring &amp; body material, see "How to Order"</i>
<b>Connection Sizes</b>	½ inch to 1¼ inch

*Note: Proper filtration is recommended to prevent damage to sealing surfaces.*

### How it Works

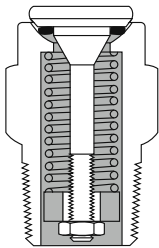

#### Closed

Resilient seal design prevents leakage. Sealing efficiency increase with increased pressure up to cracking pressure. Metal-to-metal poppet stop supports spring load, prevents sticking.

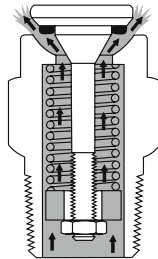

#### Open

When system pressure overcomes spring force, poppet opens. As pressure continues to rise, variable orifice between poppet and body increases, allowing greater flow.

#### Reseating

Resilient seal automatically establishes line of contact with spherical seat. Seal provides zero leakage at reseal.

### Circle Seal Controls

2301 Wardlow Circle • Corona, CA 92880-3300

Phone (951) 270-6200 Fax (951) 270-6201

www.circlesealcontrols.com • sales-circleseal@circor.com

relief valves

# 500 Series

## Flow at Cracking Pressure

Elastomeric seals: 5cc/min  
PTFE: 0.02 scfm

## Cracking Pressure Tolerance: ±5%

Cracking pressure on initial crack may be higher than cracking pressure tolerance due to inherent characteristics of seals. Cracking pressure tolerance will be greater than ±5% if set pressure is ≤ 1 psi. (Consult factory)

## Leakage, Ascending Pressure

Standard seals: 0 to 95% of cracking pressure  
Silicon & EPR: 0 to 80% of cracking pressure  
PTFE:

- Cracking pressures up to 2.4 psi: 4cc/min at 0 to 50% of cracking pressure
- Cracking pressures 2.5 psi and higher: 1cc/min at 0 to reseal pressure, 10cc/min from reseal to 90% of cracking pressures

## Leakage at Reseat Pressure

All elastomeric seals: Zero  
PTFE: 1cc/min for cracking pressures 2.5 psi and higher

0 to 10 psi (0.7 bar)

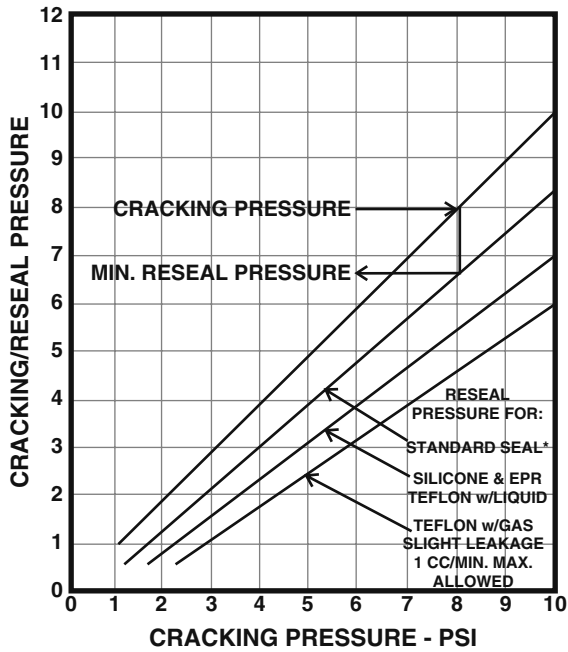

10 to 50 psi (0.7 – 3 bar)

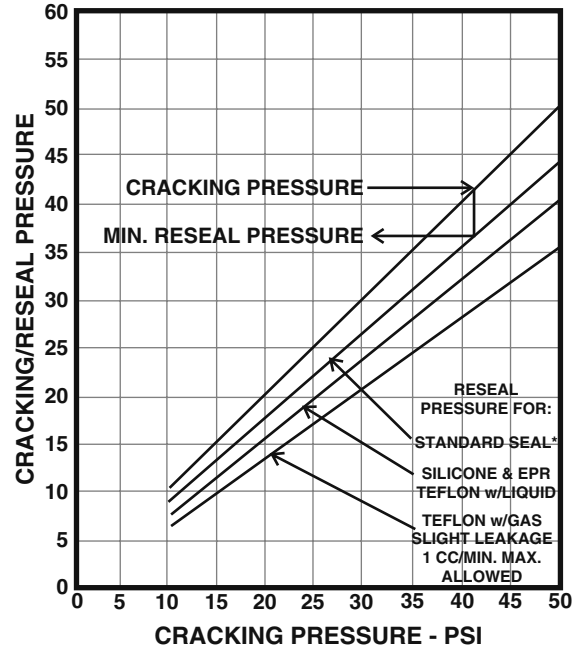

50 to 140 psi (3 – 10 bar)

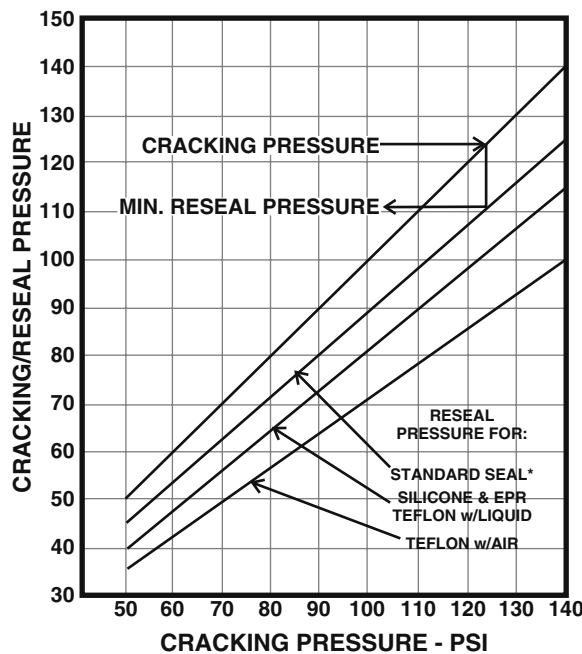

\* Standard seals:  
Buna N (559)  
Viton® (532)  
Neoprene (533)

# 500 Series

## Air and Hydraulic Flow Curves (500-M and -MP) Relief Valves

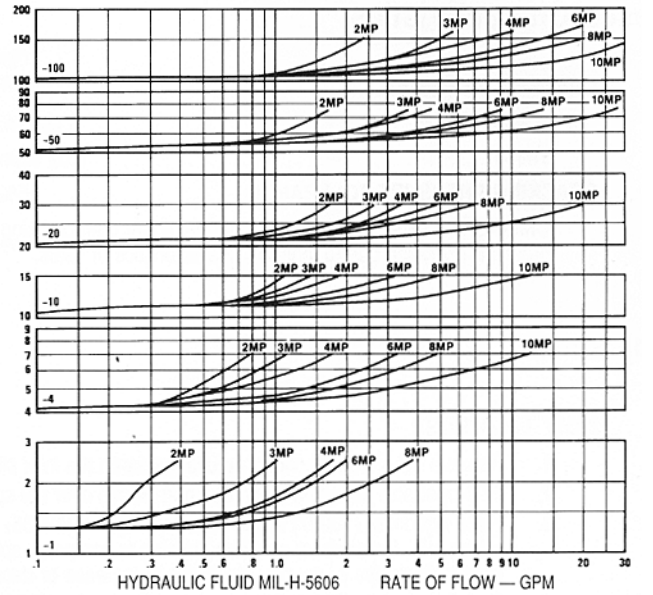
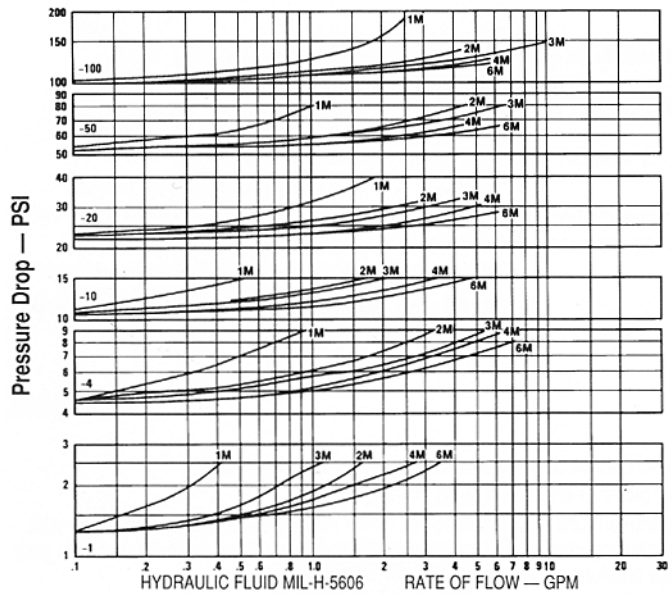
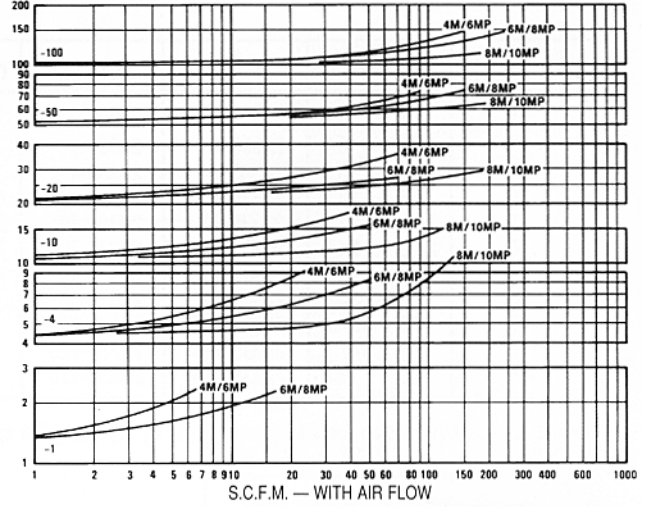
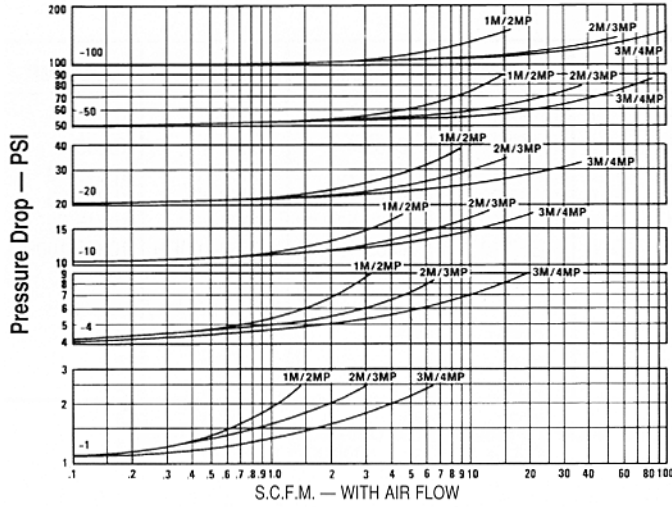

## Air Flow Curves (D500-M) Popoff Relief Valves

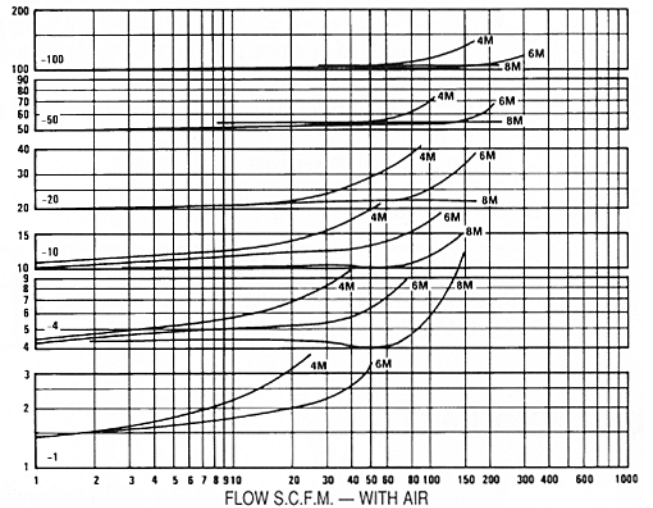
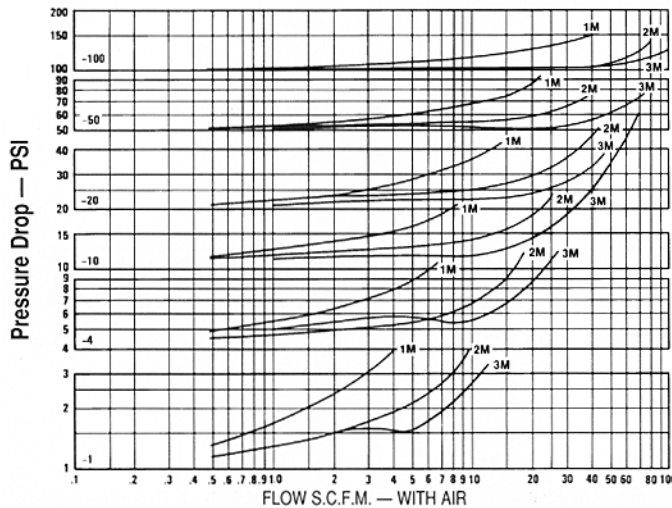

# 500 Series

## Air Flow Rates (500–M and –MP)

M = Popoff valves, 1/8"–3/8"; MP = Inline valves, 1/4"–1/2"

Crack Pressure PSIG	Percent Over Pressure Beyond Cracking (SCFM air at room temperature)								
	10%			25%			50%		
	1M/2MP	2M/3MP	3M/4MP	1M/2MP	2M/3MP	3M/4MP	1M/2MP	2M/3MP	3M/4MP
0.5	.08	.08	.08	.12	.17	.45	.14	.60	1.1
1	.10	.10	.10	.17	.35	.65	.20	.80	1.6
1.5	.12	.12	.15	.25	.46	.90	.40	1.0	2.0
2	.15	.14	.20	.34	.62	1.2	.63	1.4	2.5
2.5	.17	.17	.30	.42	.75	1.5	.80	1.8	3.1
3	.20	.21	.40	.50	.85	1.7	1.1	2.2	3.6
4	.23	.24	.50	.70	1.05	2.0	1.5	3.0	5.4
5	.28	.30	.50	.86	1.3	2.2	1.7	3.7	6.0
10	.60	.70	.60	1.65	3.2	3.8	3.2	7.0	11
15	.80	1.2	1.6	2.3	4.2	8.5	4.2	8.5	20
20	1.1	1.5	2.5	2.9	5.0	11.5	5.2	10	28
25	1.2	2.0	3.0	3.4	7.9	15	6.0	14	33
30	1.6	2.4	4.0	4.0	10.1	19.5	7.0	18	36
40	1.9	3.5	7.0	5.1	13	24.5	8.8	26	53
50	2.3	4.4	9.0	6.0	15	29	10.6	32	60
60	2.5	5.4	9.8	6.7	18	33	11.6	39	69
70	2.9	6.6	10.9	7.5	22.5	38	12.7	47	79
80	3.2	7.6	12	8.2	26	43	13.8	56	91
90	3.6	8.7	13.5	9.0	30.5	47	14.9	66	101
100	4.0	9.5	15	9.8	34	52	15.8	75	108
110	4.4	11.3	17.5	10.2	38	53.5	17.0	77.5	114
120	4.8	13.2	20.8	10.6	42.5	56.5	18.3	80	122
130	5.2	14.9	24	11	47	58.5	19.6	83	131
140	5.6	16.5	27.5	11.5	51	61.5	20.9	87	138
150	6.0	18	30	12	56	63	22.0	90	145

M = Popoff valves, 1/2"–1"; MP = Inline valves, 3/8"–1 1/4"

Crack Pressure PSIG	Percent Over Pressure Beyond Cracking (SCFM air at room temperature)								
	10%			25%			50%		
	4M/6MP	6M/8MP	8M/10MP	4M/6MP	6M/8MP	8M/10MP	4M/6MP	6M/8MP	8M/10MP
.5	.07	.07	—	.50	.50	—	.80	2.2	—
1	.10	.10	—	.70	.70	—	1.7	3.2	—
1.5	.30	.30	—	1.0	1.4	—	2.2	5.5	—
2	.50	.50	—	1.2	1.7	—	3.0	7.0	—
2.5	.60	.60	—	1.8	3.0	—	4.2	10.5	—
3	.80	.80	—	2.2	4.0	—	5.0	13	—
4	1.0	1.0	1.5	3.0	5.0	30	7.5	17	56
5	1.0	1.2	2.5	3.5	6.0	34	9.0	20	64
10	1.0	2.4	7.0	6.0	12	60	19	40	115
15	1.6	3.0	7.0	8.5	22	60	27	80	160
20	2.0	5.0	7.0	10	30	60	34	110	190
25	3.0	5.5	9.0	13.5	34	72	43	116	—
30	3.5	6.0	11.5	16	37	80	50	121	—
40	5.5	8.5	18	24	48	115	72	136	—
50	7.0	10	23	30	56	140	90	150	—
60	11	13	35	38	64	160	100	165	—
70	15	17	59	47	72	185	111	182	—
80	20	21	77	56	81	215	123	204	—
90	26	26	88	68	94	235	138	225	—
100	30	30	100	75	105	250	150	240	—
110	33	38	115	80	112	258	166	—	—
120	37	47	132	86	125	270	183	—	—
130	41	57	150	93	150	282	201	—	—
140	46	71	175	102	163	290	222	—	—
150	50	80	190	110	175	300	240	—	—

# 500 Series

## Air Flow Rates (D500–M)

### Popoff valves with deflector cap, 1/8"–3/8"

Crack Pressure PSIG	Percent Over Pressure Beyond Cracking (SCFM air at room temperature)								
	10%			25%			50%		
	1M	2M	3M	1M	2M	3M	1M	2M	3M
.5	.12	.20	.15	.24	.50	.50	.44	1.2	1.1
1	.21	.30	.30	.40	.85	.85	.73	2.0	1.9
1.5	.21	.30	.30	.42	1.0	1.0	.80	2.7	3.1
2	.21	.30	.30	.45	1.2	1.2	.95	3.5	5.0
2.5	.22	.30	.30	.49	1.3	1.3	1.1	4.3	6.2
3	.23	.30	.30	.52	1.6	1.6	1.25	5.4	8.0
4	.23	.30	.30	.58	2.1	2.1	1.5	7.5	12
5	.32	.30	.30	.60	2.2	4.5	1.7	8.3	14
10	.70	.34	.40	1.6	2.5	14	3.2	12.6	23
15	1.4	1.3	1.5	2.0	6.0	18	3.9	16.5	29
20	1.8	2.2	3.0	2.7	10	23	5.4	21	36
25	1.9	3.0	8.0	2.8	11.5	27	6.0	23	40
30	2.0	4.0	14	3.0	14	32	7.0	27	47
40	2.3	5.9	26	3.5	18	42	9.0	33	59
50	2.4	8.0	39	3.8	25	54	10.5	40	74
60	3.2	17	43	4.6	33	62	11.4	46	—
70	4.0	26	47	5.5	41	70	12.4	52	—
80	4.9	36	52	6.4	50	79	13.7	59	—
90	5.9	46	58	7.5	61	89	15	67	—
100	7.0	56	65	8.5	72	100	16	76	—
110	7.3	56	65	9.5	73	113	24	80	—
120	7.7	57	66	12.8	74	127	33	84	—
130	8.1	58	67	16.2	76	142	43	89	—
140	8.6	59	68	20	78	158	53	96	—
150	9.0	61	70	25	80	176	60	104	—

### Popoff valves with deflector cap, 1/2"–1"

Crack Pressure PSIG	Percent Over Pressure Beyond Cracking (SCFM air at room temperature)								
	10%			25%			50%		
	4M	6M	8M	4M	6M	8M	4M	6M	8M
.5	.15	.15	—	.30	.30	—	1.0	1.0	—
1	.30	.30	—	.50	.50	—	1.7	1.7	—
1.5	.40	.40	—	.60	1.5	—	3.2	7.5	—
2	.50	.60	—	.90	3.0	—	5.0	14.5	—
2.5	.60	.70	—	1.1	4.0	—	6.5	21	—
3	.70	1.0	—	1.4	5.5	—	9.0	29	—
4	1.0	1.5	—	3.0	9.0	—	13	45	—
5	1.0	1.8	—	4.0	13	—	15.5	49	—
10	1.5	4.0	92	10	36	115	28	75	145
15	9.0	26	127	22	66	—	42	101	—
20	18	50	170	36	100	—	58	131	—
25	21	60	173	43	112	—	65	—	—
30	25	74	177	51	128	—	74	—	—
40	33	100	188	67	158	—	91	—	—
50	42	130	200	85	195	—	110	—	—
60	49	148	225	95	220	—	—	—	—
70	56	167	251	106	247	—	—	—	—
80	64	188	278	117	275	—	—	—	—
90	73	212	308	130	305	—	—	—	—
100	85	240	340	145	340	—	—	—	—
110	89	246	355	152	347	—	—	—	—
120	93	253	372	159	355	—	—	—	—
130	98	261	390	167	363	—	—	—	—
140	103	270	415	176	375	—	—	—	—
150	110	280	440	185	390	—	—	—	—

# 500 Series

## How to Order

**D 5 59 A - 2 M - 10**

### VARIATION\*\*

- D** Deflector cap
- K** Cryogenic service, special cleaning & testing (stainless steel only)

### SEAL MATERIAL & TEMPERATURE RANGE

- 20** PTFE  
520 Series\*\*: -100° F to +400° F (-73°C to +204°C)  
K520 Series\*\*: -320° F to +165° F (-196°C to +74°C)
- 24** Silicone\*, -70° F to +450° F (-57°C to +232°C)
- 32** Viton®, -20° F to +400° F (-29°C to +204°C)
- 33** Neoprene, -40° F to +300° F (-40°C to +149°C)
- 59** Buna N, -65° F to +275° F (-54°C to +135°C)
- 62** Ethylene propylene, -65° F to +300° F (-54°C to +149°C)
- 80** PTFE, -320° F to +165° F (-196°C to +74°C)

### CRACKING PRESSURE

Specify cracking pressure setting in psig (0.5 – 150 psig)

### CONNECTION

See "Valve Size & Type Codes" table, below

### VALVE SIZE

Pipe sizes in 1/8" increments (see "Valve Size & Type Codes" table, below)

### BODY MATERIAL

- A** Aluminum
- B** Brass
- T** 303 stainless steel†
- T1** 316 stainless steel

'D' Variation: Prefixed part number is supplied with a cap which diverts high pressure blasts from personnel and instruments, and serves as a rain and dust shield.

\* Not available over 74.9 psi (5 bar)

\*\* 520 Series: PTFE o-ring

K520 Series: Polished PTFE o-ring, cryogenic testing and serialization

580 Series: Polished PTFE o-ring

† Not available for PED applications

†† Blank if not required

To specify PED certification, add PED prefix to the part number.

Please consult your Circle Seal Controls distributor or our factory for information on special connections, operating pressures and temperature ranges.

### Repair Kits

In normal service, the only part(s) which may require replacement is(are) the seal(s). A repair kit may be ordered by placing a "K/" in front of the complete part number (i.e. K/559A-2M-10).

### Valve Size & Codes

Size	Pipe Thread Male	Pipe Thread Male/Female	British Pipe Thread Male/Female	British Taper Pipe Male
1/8"	-1M	—	—	-1S
1/4"	-2M	-2MP	-2SX	-2S
3/8"	-3M	-3MP	-3SX	-3S
1/2"	-4M	-4MP	-4SX	-4S
3/4"	-6M	-6MP	-6SX	-6S
1"	-8M	-8MP	—	-8S
1 1/4"	—	-10MP	—	—

## Dimensions (Inches)

### Popoff

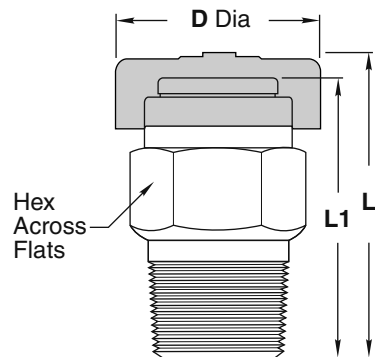

Pipe Size, Male	L	L1	Hex	D Dia. Max.
1/8"	1.14	0.98	1/2	0.63
1/4"	1.38	1.20	5/8	0.90
3/8"	1.43	1.25	3/4	1.21
1/2"	1.98	1.74	1	1.45
3/4"	2.31	2.07	1 1/8	1.45
1"	3.16	2.86	1 1/2	1.89

### Inline

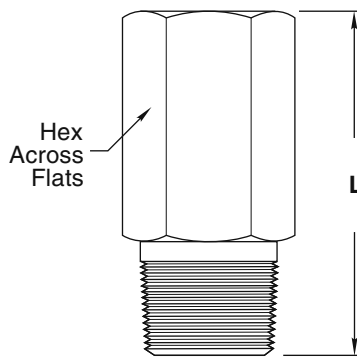

Pipe Size, Male & Female	L	Hex
1/4"	1.62	3/4
3/8"	2.08	7/8
1/2"	2.34	1
3/4"	2.72	1 1/4
1"	3.62	1 1/2
1 1/4"	4.67	1 3/4

## For Your Safety

It is solely the responsibility of the system designer and user to select products suitable for their specific application requirements and to ensure proper installation, operation, and maintenance of these products. Material compatibility, product ratings and application details should be considered in the selection. Improper selection or use of products described herein can cause personal injury or property damage.

Freon® is a registered trademark of DuPont.

Viton® is a registered trademark of DuPont Dow Elastomers.

## L500 Series

*Low Pressure Relief Valve 0.2–15 psig*

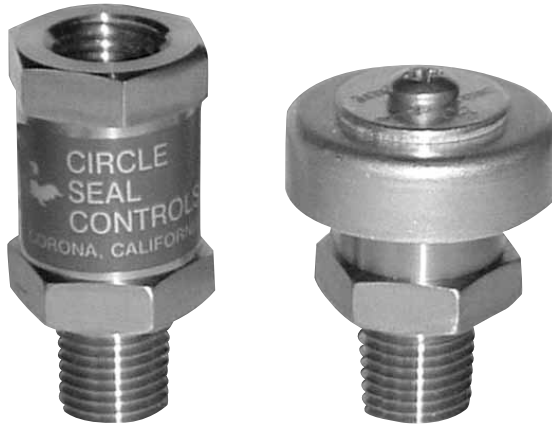

### Features

- Accurate cracking pressure
- Eliminates sticking
- In-line or vent to atmosphere with deflector cap
- Adjustable cracking pressure
- Zero leakage
- Optional factory preset

### Technical Data

<b>Body Construction Materials</b>	Brass, 316 stainless steel
<b>O-ring Materials</b>	Buna N, ethylene propylene, Kalrez®, neoprene, silicone, Viton®
<b>Spring Materials</b>	302 stainless steel
<b>Cracking Pressure</b>	.2 psig to 15 psig
<b>Operating Pressure</b>	0 to 25 psig (1.72 BAR)
<b>Inline Valve Proof Pressure</b>	37.5 psig (2.59 BAR)
<b>Inline Valve Burst Pressure</b>	Above 100 psig (6.89 BAR)
<b>Temperature Range</b>	-70° F to +550° F (-57° C to +288° C)
<b>Connection Sizes</b>	¼" to ½"
<b>Orifice Size</b>	0.281"

### Circle Seal Controls

2301 Wardlow Circle • Corona, CA 92880-3300  
 Phone (951) 270-6200 Fax (951) 270-6201  
[www.circlesealcontrols.com](http://www.circlesealcontrols.com) • [sales-circleseal@circor.com](mailto:sales-circleseal@circor.com)

relief valves



# L500 Series

## Dimensions

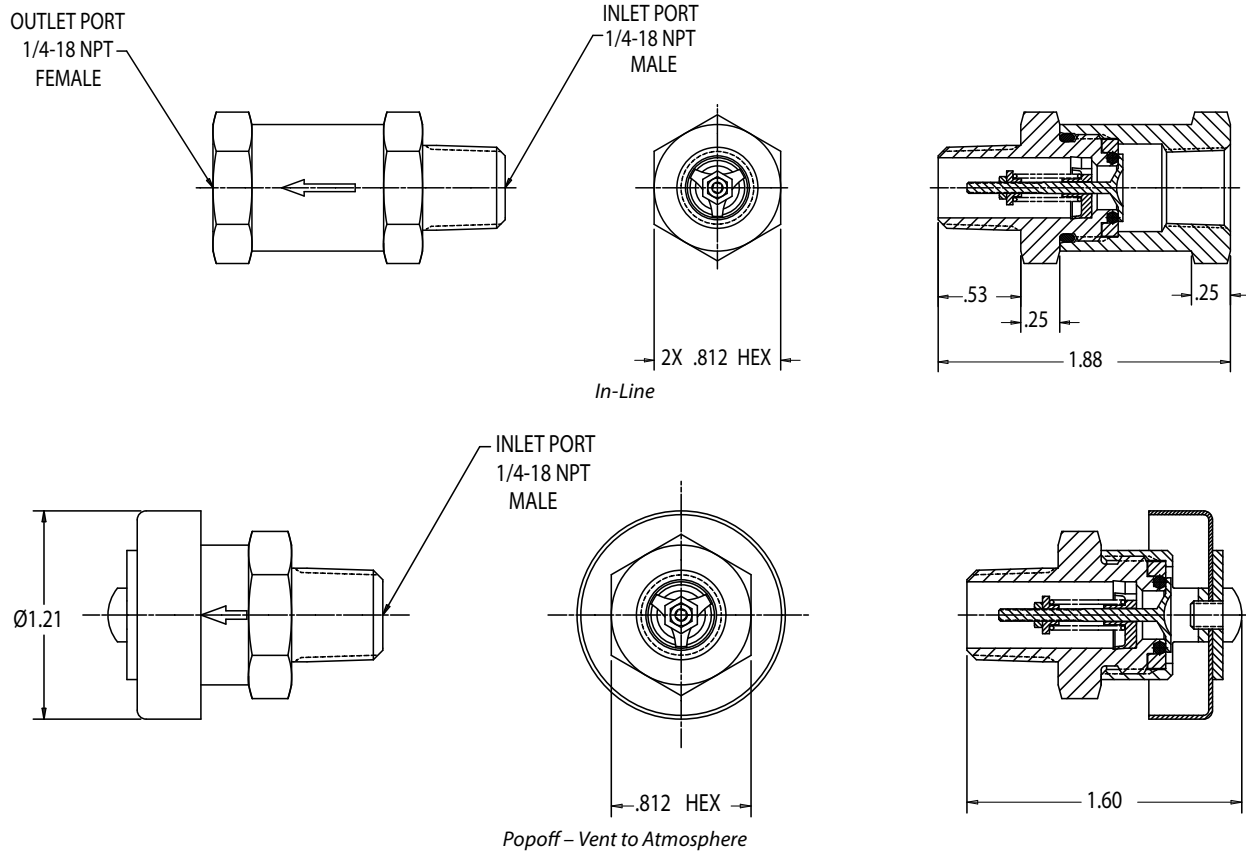

**CSC L500-2MP Relief Valve (Inline) Flow Data**  
(ESR 21625)

Spring Dash #	CP (PSI)	CP	RP	Flow (at % Over CP)		
				10%	25%	50%
0.5						
	0.3	0.3	0.24	0.06 SCFM	0.16 SCFM	0.32 SCFM
	0.5	0.5	0.44	0.12 SCFM	0.22 SCFM	0.64 SCFM
	0.7	0.7	0.55	0.34 SCFM	1.12 SCFM	1.9 SCFM
1.5						
	0.9	0.9	0.78	0.62 SCFM	1.12 SCFM	1.9 SCFM
	1.2	1.2	1	0.72 SCFM	1.71 SCFM	2.65 SCFM
	1.5	1.5	1.3	0.91 SCFM	1.83 SCFM	3.4 SCFM
	1.8	1.8	1.6	0.84 SCFM	1.89 SCFM	3.75 SCFM
	2.1	2.1	1.9	0.96 SCFM	1.96 SCFM	4.62 SCFM
3.5						
	2.2	2.2	2	1.04 SCFM	2.1 SCFM	4.3 SCFM
	2.7	2.7	2.5	1.28 SCFM	2.3 SCFM	5.2 SCFM
	3.2	3.2	2.9	1.32 SCFM	3.1 SCFM	5.41 SCFM
	3.7	3.7	3.4	1.35 SCFM	3.5 SCFM	6.5 SCFM
	4.2	4.2	3.9	1.64 SCFM	4.85 SCFM	7.25 SCFM
7.5						
	4.9	4.9	4.6	1.75 SCFM	5.2 SCFM	7.75 SCFM
	6	6	5.7	2.2 SCFM	5.5 SCFM	9.2 SCFM
	8	8	7.7	1.45 SCFM	6.05 SCFM	10.85 SCFM
	9	9	8.8	2.3 SCFM	6.8 SCFM	11.18 SCFM
	10	10	9.7	2.35 SCFM	6.32 SCFM	12.29 SCFM

Tested By L. Whitehead & F. Smith  
6/3/2003  
FLOWMETER EQUIPMENT  
SERNO HRD051603/1; HRD051603/2; 001; 004

## How to Order

**D L5 33 B - 2M - 5**

### VARIATION\*

D Deflector cap

### SEAT MATERIAL & TEMPERATURE RANGE

- 24 Silicone, -70° F to +450° F (-57°C to +232°C)
- 32 Viton®, -20° F to +400° F (-29°C to +204°C)
- 33 Neoprene, -40° F to +300° F (-40°C to +149°C)
- 62 Ethylene propylene, -65° F to +300° F (-54°C to +149°C)
- 65 Kalrez®, -40° F to +550° F (-40°C to +288°C)
- 77 Buna N, -65° F to +275° F (-54°C to +135°C)

### CRACKING PRESSURE

Specify cracking pressure setting in psig (i.e. 5 = 5 psig set)

### INLET/OUTLET PORTS

- 2M 1/4" pipe thread male (popoff)
- 2MP 1/4" pipe thread male/female (in-line)
- 3M 3/8" pipe thread male (popoff)
- 3MP 3/8" pipe thread male/female (in-line)
- 4MP 1/2" pipe thread male/female (in-line)

### BODY MATERIAL

- B Brass
- T1 316 stainless steel

\* blank if not required

## HP500 Series

*High Pressure Popoff and Inline Relief Valves*  
 150 to 575 psig (10 – 40 bar)



Inline version

### Features

- Very accurate cracking pressure
- Zero leakage up to 95% of cracking pressure
- 100% seat leakage tested
- Tamper-proof adjustment
- PED certifications and CE marking available for most models

### Applications

- System overpressure protection
- Storage tanks
- Freon® recovery systems
- Medical equipment
- Refrigeration & heating equipment
- Measuring & dispensing pumps
- Communications equipment
- Process control instruments
- R & D pilot plants

### Technical Data

<b>Body Construction Materials</b>	Brass, 316 stainless steel
<b>O-ring Materials</b>	Buna N, ethylene propylene, neoprene, silicone, and Viton®
<b>Spring Material</b>	17-7 PH stainless steel
<b>Poppet</b>	Brass, 316 stainless steel
<b>Shroud</b>	Brass, 316 stainless steel
<b>Operating Pressure</b>	• ¼" pipe: 150 to 575 psig (10 to 40 bar) • ½" pipe: 150 to 450 psig (10 to 31 bar)
<b>Temperature Range</b>	-65° F to +350° F (-54° C to +177° C) <i>Based on O-ring &amp; body material, see "How to Order"</i>
<b>Connection Sizes</b>	¼" to ½" male and female pipe

### How it Works

*Note: Proper filtration is recommended to prevent damage to sealing surfaces.*

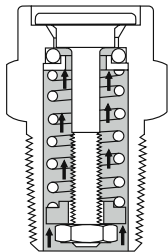

#### Closed

The specially-designed poppet seals on the elastomeric O-ring. The increasing pressure within the valve seals tightly against the poppet and prevents leakage to 95% of the cracking pressure. The metal-to-metal stop, on the low pressure side, supports the spring load and prevents seal deformations.

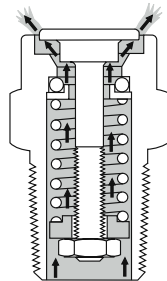

#### Open

The excess pressure is vented instantly when the system pressure overcomes the spring force and opens the poppet. Large flow passages, at the inlet and at the poppet opening, assure minimum pressure rise.

#### Reseating

Repeated, positive reseating occurs at better than 90% of the cracking pressure when the spring action retracts the poppet, reestablishing the seal between the elastomeric O-ring and the poppet shoulder.

relief valves

### Circle Seal Controls

2301 Wardlow Circle • Corona, CA 92880-3300  
 Phone (951) 270-6200 Fax (951) 270-6201  
 www.circlesealcontrols.com • sales-circleseal@circor.com

# HP500 Series

## Dimensions

### Popoff

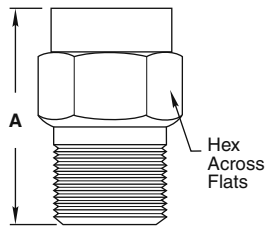

### Vent to Atmosphere, Male Pipe Thread

Dash No.	Size	A	Hex
-2M	¼"	1.17	0.625
-4M	½"	1.91	1.000

### Inline

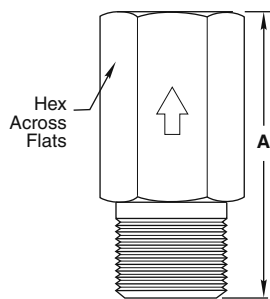

### Inline, Male/Female Pipe Thread

Dash No.	Size	A	Hex
-2MP	¼"	1.92	0.750
-4MP	½"	2.63	1.125

### Replacement Springs: ¼"

Range	-2M/-2MP
150-175	10262-40PH
176-275	10262-90PH
276-374	10262-120PH
375-450	10262-175PH
451-575	10262-500PH

### Replacement Springs: ½"

Range	-4M/-4MP
150-250	10462-175PH
251-350	10462-300PH
351-450	10462-400PH

## Flow Curves

Air @ 10% Overpressure

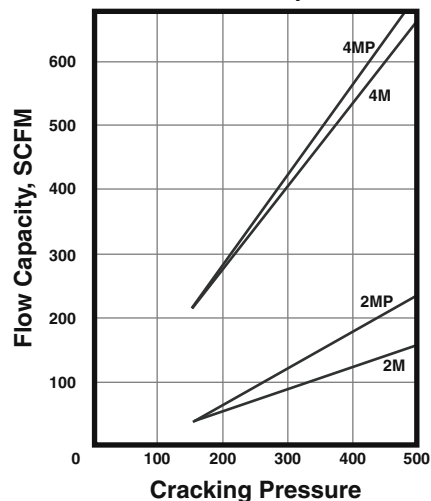

## How to Order

### HP5 59 B - 2 M - 150

#### O-RING MATERIAL & TEMPERATURE

- 24** Silicone, -70° F to +450° F (-57°C to +232°C)
- 32** Viton®, -20° F to +400° F (-29°C to +204°C)
- 33** Neoprene, -40° F to +300° F (-40°C to +149°C)
- 59** Buna N, -65° F to +275° F (-54°C to +135°C)
- 62** Ethylene propylene, -65° F to +300° F (-54°C to +149°C)

#### BODY MATERIAL

- B** Brass†
- T1** 316 stainless steel

#### CRACKING PRESSURE\*

Specify cracking pressure setting in psig (150 - 575 psig)

#### CONNECTIONS-INLET/OUTLET

- M** Popoff male pipe
- MP** Inline male pipe by female pipe

#### VALVE SIZE

Pipe sizes in ⅛" increments  
**2** ¼"  
**4** ½"\*

\* Maximum cracking pressure is 450 psig for ½" valve sizes.

† For PED applications, brass bodies are limited to a maximum temperature use of +100° F (+38° C)

To specify PED certification, add PED prefix to the part number.

Please consult your Circle Seal Controls Distributor or our factory for information on special connections, materials, sizes, o-rings, operating pressures and temperature ranges.

### Cracking Pressure

Tolerance: ±5%

Initial crack may be higher than cracking pressure tolerance due to inherent characteristics of seals.

Flow at cracking pressure for elastomeric seals is 5cc/min.

**Leakage:** Ascending pressure 0 up to 95% of cracking pressure

**Reseal pressure:** 90% of cracking pressure

**Leakage at reseal pressure:** Zero

## For Your Safety

It is solely the responsibility of the system designer and user to select products suitable for their specific application requirements and to ensure proper installation, operation, and maintenance of these products. Material compatibility, product ratings and application details should be considered in the selection. Improper selection or use of products described herein can cause personal injury or property damage.

Viton® is a registered trademark of DuPont Dow Elastomers.

## 5100 Series

*Inline Relief Valves*  
 10 to 2400 psig (0.7 – 165 bar)



### Features

- Zero leakage up to 95% of cracking pressure
- Positive reseal at high percentage of cracking pressure
- Accurate set pressure
- Wide range of cracking pressure
- Tamper-proof adjustment
- PED certifications and CE marking available for most models

### Technical Data

<b>Body Construction Materials</b>	Brass, steel, 303 or 316 stainless steel
<b>O-ring Materials</b>	Buna N, ethylene propylene, neoprene, PTFE, and Viton®
<b>Spring Material</b>	17-7 PH stainless steel
<b>Operating Pressure</b>	0 to 2400 psig (166 bar)
<b>Proof Pressure</b>	3600 psig (248 bar)
<b>Burst Pressure</b>	Over 5000 psig (345 bar)
<b>Temperature Range</b>	-320° F to +400° F (-196° C to +204° F) <i>Based on O-ring material, see "How to Order"</i>
<b>Connection Sizes</b>	1/8" to 1 1/4"

*Note: Proper filtration is recommended to prevent damage to sealing surfaces.*

### How it Works

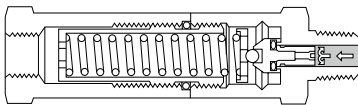

#### Closed

The spring load is carried by a metal-to-metal stop. The O-ring provides a leak-tight seal. Sealing efficiency increases as the pressure increases up to the cracking pressure.

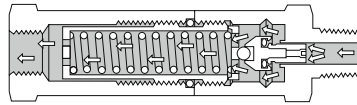

#### Cracking

The ports in poppet open fully and eliminate rapid increase in the pressure. The flow is throttled between the poppet shoulder and the seat, which provides regularly increasing flow area with increasing flow rates.

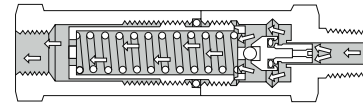

#### Open

The inline construction and full flow ports permit maximum flow with minimum increase in the system pressure.

relief valves

### Circle Seal Controls

2301 Wardlow Circle • Corona, CA 92880-3300

Phone (951) 270-6200 Fax (951) 270-6201

www.circlesealcontrols.com • sales-circleseal@circor.com

# 5100 Series

## Cracking Pressure Spring Ranges

Consult your local distributor or the factory for replacement spring part numbers. (Please have your complete valve part number ready when calling.)

### Cracking Pressure Ranges (psig)

10–15	82–117	346–450	1201–1400
16–24	118–162	451–575	1401–1900
25–41	163–230	576–710	1901–2400
42–57	231–285	711–999	
58–81	286–345	1000–1200	

## Adjustment

The 5100 Series relief valve is adjustable to  $\pm 15\%$  of its nominal cracking pressure as follows:

1. Remove discharge line (in-line mounted unit) or override ring & rod (ASME type)
2. "Break" body joint by wrenching hexes. DO NOT USE PIPE WRENCH.
3. Insert proper size hex wrench (see table below) into the outlet end and turn clockwise to increase the cracking pressure, or counterclockwise to decrease.
4. After adjustment, hold the hex wrench stationary relative to the inlet end and turn the body to tighten the joint.
5. Test adjusted unit for cracking pressure.

### Hex Wrench Size

Size	Nominal Cracking Pressure (psig)	
	450 & Under	451 & Over
1/8"	7/32"	7/32"
1/4"	5/16"	1/4"
3/8"	5/16"	1/4"
1/2"	1/2"	3/8"
3/4"	5/8"	1/2"
1"	5/8"	1/2"
1 1/4"	3/4"	3/4"

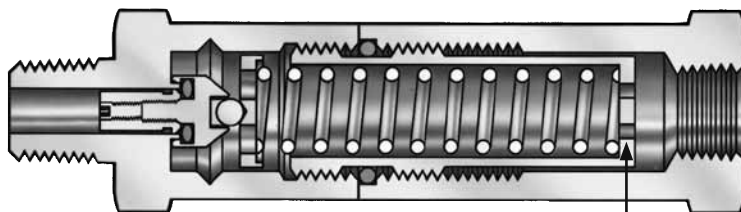

Hex adjustment screw

## Air Flow Rates (5100-MP)

### Inline valves, 1/2"–1"

Crack Pressure PSIG	Percent Over Pressure Beyond Cracking (SCFM air at room temperature)							
	10%				25%			
	1MP	2MP/3MP	4MP	6MP/8MP	1MP	2MP/3MP	4MP	6MP/8MP
15	1.0	1.5	5.0	9.0	3.0	5.0	50	52
20	1.5	2.0	10	12	4.0	5.0	60	63
25	2.0	2.7	25	27	5.4	6.5	65	67
30	2.4	4.6	30	36	6.2	13	68	71
40	3.0	5.5	34	55	6.5	25	72	100
50	3.0	10.5	40	65	8.0	29	74	110
75	4.2	14	50	70	13	38	80	114
100	6.0	25	54	90	17	55	90	130
125	8.5	32	70	120	22	58	110	136
150	10	36	72	150	27	78	115	200
200	13	40	135	190	40	96	250	375
250	16	50	150	210	43	115	280	450
300	20	60	180	225	52	127	400	600
400	25	80	270	270	68	150	600	900
500	36	46	110	190	108	120	320	700
750	45	58	130	210	90	130	420	1200
1000	47	64	170	210	160	160	620	1280
1200	67	74	240	250	200	200	1000	1500
1400	84	84	450	395	—	—	—	—
1600	110	110	720	405	—	—	—	—
1800	160	160	810	510	—	—	—	—
2000	190	190	850	515	—	—	—	—
2200	220	220	900	520	—	—	—	—
2400	240	240	990	675	—	—	—	—

# 5100 Series

## Dimensions (inches)

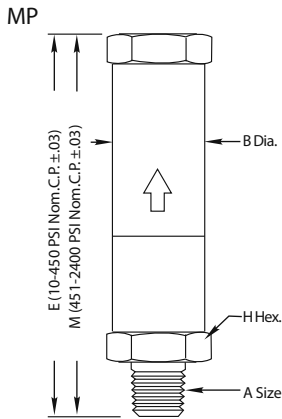

### 5100 Series, Inline

Prod. No.	A	E	M	B Dia. H Hex
-1MP	1/8"	2.89	3.49*	0.81*
-2MP	1/4"	3.34	4.24	1.00
-3MP	3/8"	3.36	4.26	1.00
-4MP	1/2"	4.15	5.05	1.25
-6MP	3/4"	5.61	7.11	1.50
-8MP	1"	5.79	7.29*	1.50
-10MP	1 1/4"*	7.46	10.22	2.00

\* 1/8" size: for cracking pressure 1201–2400 psig, 'M' is 3.95, 'B' and 'H' are 1.00  
 1" size: for cracking pressure 1201–2400 psig, 'M' is 7.32  
 1 1/4" size: not available above 1200 psig

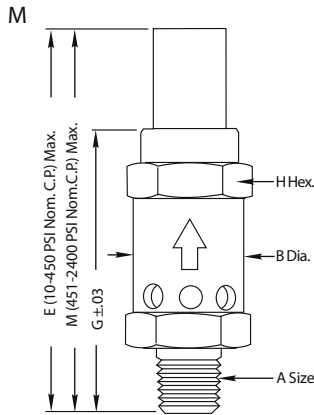

### 5100 Series, Popoff

Prod. No.	A	E	M	G	B Dia. H Hex
-1M	1/8"	2.56	3.16*	2.39*	0.81*
-2M	1/4"	2.87	3.77	2.65	1.00
-3M	3/8"	2.89	3.79	2.74	1.00
-4M	1/2"	3.59	4.49	3.27	1.25
-6M	3/4"	5.00	6.50	4.16	1.50
-8M	1"	5.18	6.68	4.34	1.50
-10M	1 1/4"*	6.70	8.65	4.96	2.00

\* 1/8" size: for cracking pressure 1201–2400 psig, 'M' is 3.58, 'G' is 2.48, 'B' and 'H' are 1.00  
 1 1/4" size: not available above 1200 psig

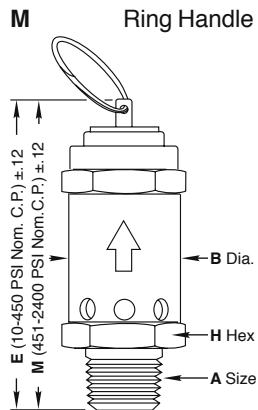
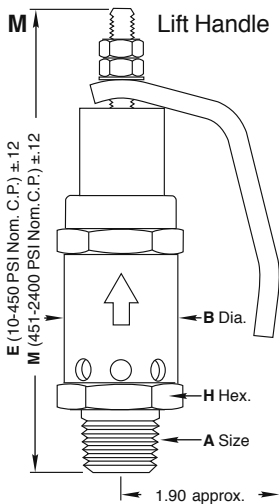

### M5100 Series, Popoff with Manual Override

Prod. No.*	A	E	M	B Dia. H Hex
-1M	1/8"	2.84	3.45**	0.81**
-2M	1/4"	3.16	4.06	1.00
-3M	3/8"	3.19	4.09	1.00
-4M	1/2"	3.86	5.51	1.25
-6M	3/4"	5.41	7.54	1.50
-8M	1"	5.59	7.72	1.50
-10M	1 1/4"*	6.95	10.42	2.00

\* Ring handle is supplied for 1M, 2M, and 3M. For larger sizes, ring handle only supplied for cracking pressure up to 450 psi.

\*\* 1/8" size: for cracking pressure 1201–2400 psig, 'M' is 3.84, 'B' and 'H' are 1.00  
 1 1/4" size: not available above 1200 psig

# 5100 Series

## Hydraulic Flow Curves

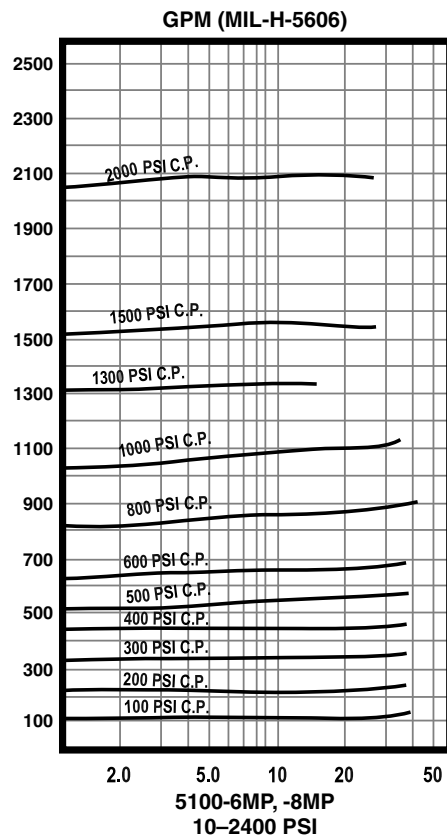
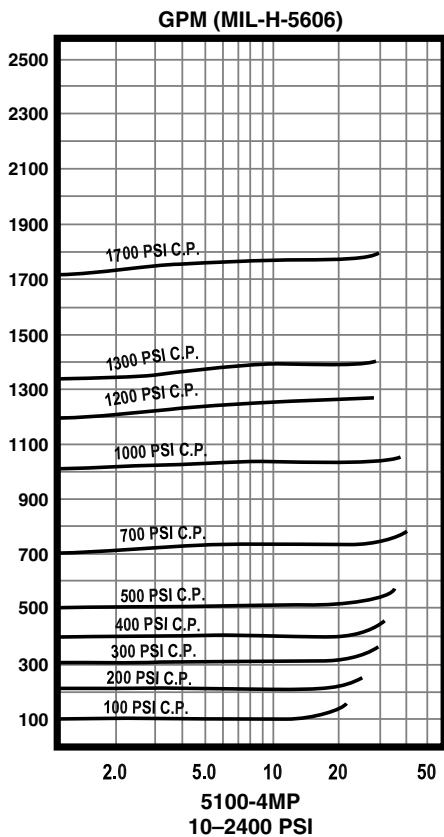
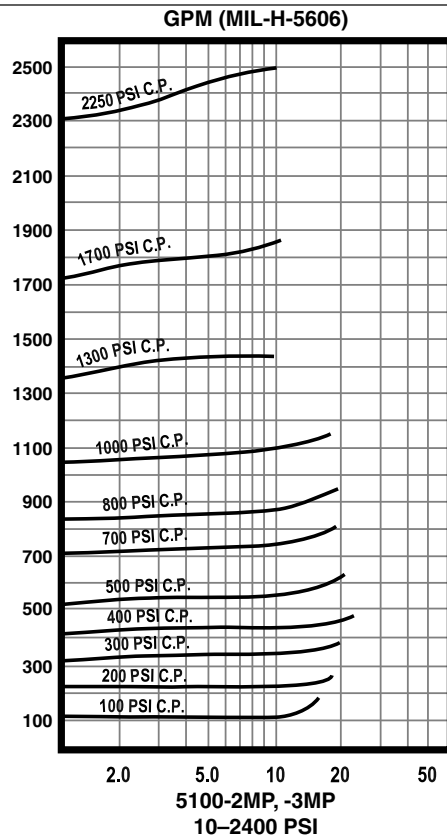
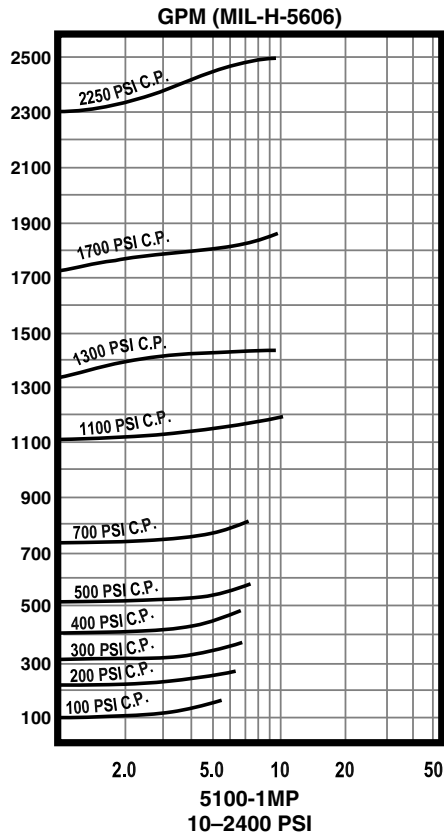

# 5100 Series

## Cracking & Reseal Pressure

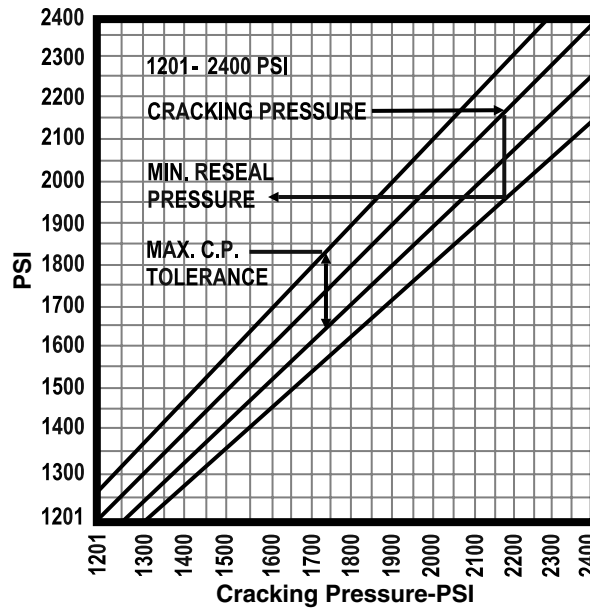
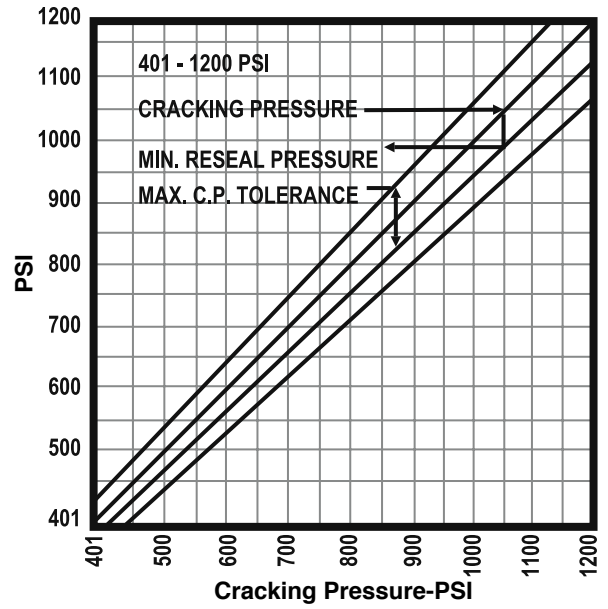
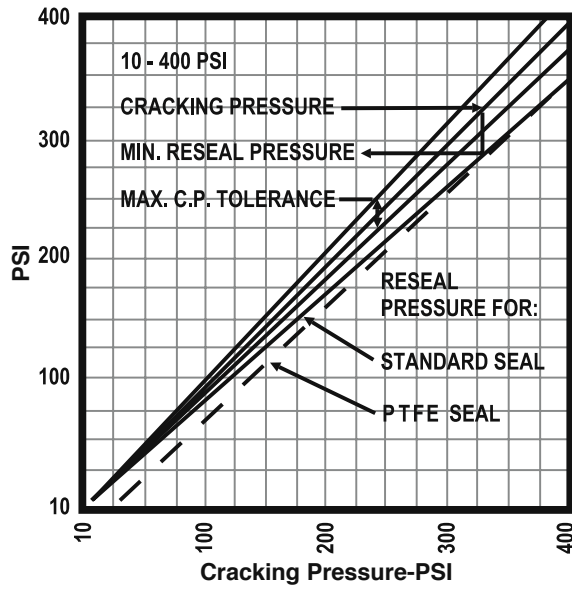

### Definitions

1. *Cracking pressure* is defined as 5cc/min with gas (0.2 scfm for 5120 Series)
2. *Reseat point* is the point at which the valve closes, cutting off virtually all flow.
3. The *reseal point* is the point at which the valve seals absolutely tight so that there is no leakage detectable by normal means of measurement.



# 5100 Series

## How to Order

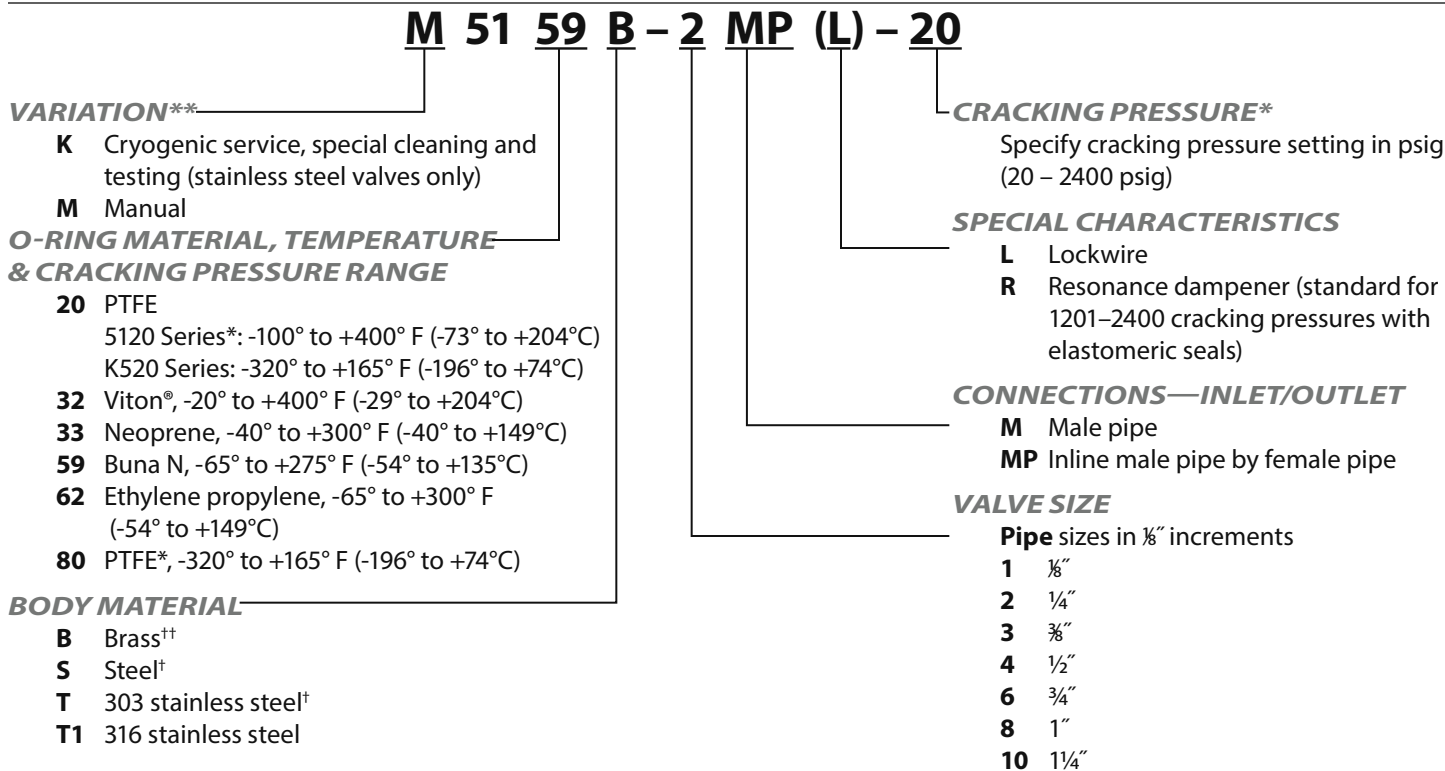

\* Unit is not rated for liquid cryogenic service below -100° F (-73° C).

\*\* Blank if not required

† Not available for PED applications

†† For PED applications, brass bodies are limited to a maximum temperature use of +100° F (+38° C)

O-rings of PTFE: Minimum cracking pressure is 20 psi; not available for use above 1200 psi in 3/4" and larger sizes.

To specify PED certification, add PED prefix to the part number.

### Repair Kit

In normal service, the only part(s) which may require replacement is(are) the seal(s). A repair kit may be ordered by placing a 'K/' in front of the complete part number (i.e. K/5159B-2MP-20).

Please consult your Circle Seal Controls Distributor or our factory for information on special connections, materials, sizes, o-rings, operating pressures and temperature ranges.

### Cracking Pressure Tolerance: ±5%

Cracking pressures below 20 psig have a tolerance of ±20%.

### Flow at cracking pressure: Elastomeric seals = 5cc/min

PTFE seals = 0.02 scfm

### Reseal pressure\*\*\*

	Crack Pressure	Reseal Pressures
Elastomeric seals	C.P. > 100 psi	90% of C.P.
	C.P. < 100 psi	70% to 89% of C.P.
PTFE seals	C.P. > 450 psi	90% of C.P.
	C.P. < 450 psi	52% to 90% of C.P.

\*\*\* The reseal point is the point at which the valve seals absolutely tight so that there is no leakage detectable by normal means of measurement. The point at which the valve closes, cutting off virtually all flow, is called the reseal point. The reseal point is substantially above the reseat.

### Leakage at reseal pressure

Elastomeric seals Ascending pressure = zero up to 95% of cracking pressure  
Descending pressure = zero at reseal and below

PTFE seals Ascending pressure = zero up to reseal pressure, then 10cc/min between reseal and cracking pressure  
Descending pressure = zero at reseal, except with cracking pressure below 451 psi, then 1cc/min maximum

### First crack pressure after standing unactuated for a prolonged period

Set pressure of...	5–19 psi	125% of cracking pressure
	20–29 psi	120% of cracking pressure
	30–49 psi	115% of cracking pressure
	50 psi and higher	110% of cracking pressure

## D500 Series M5100 Series

ASME Safety Relief Valves

D500 Series: 15 to 150 psig (1 – 10 bar)

M5100 Series: 20 to 1200 psig (1 – 83 bar)



D500 Series

M5100 Series

### Features

D500 Series features cap design

M5100 Series offered with ring or lift handle

MD500 Series features cup design with manual override ring

Zero leakage from 0 psi up to 70% of the marked set pressure

### Technical Data

<b>ASME</b>	American Society of Mechanical Engineers
<b>Body Construction Materials</b>	Naval brass, 303 and 316 stainless steel
<b>O-ring Materials</b>	<ul style="list-style-type: none"> <li>D500 Series: Buna N, neoprene, PTFE, Viton®, EPDM, and silicone</li> <li>M5100 Series: Buna N, neoprene, PTFE, Viton®, and EPDM</li> </ul>
<b>Set Pressure</b>	<ul style="list-style-type: none"> <li>D500 Series: 15 to 150 psig (¼")</li> <li>M5100 Series: 20 to 1200 psig (⅛", ¼", 1"); 50 to 1200 psig (¼", ⅜", ½")</li> </ul>
<b>Temperature Range</b>	-100° F to +400° F (-73° C to +204° F) <i>Based on O-ring &amp; body material, see "How to Order"</i>
<b>Connection Sizes</b>	<ul style="list-style-type: none"> <li>D500 Series: ¼" male pipe</li> <li>M5100 Series: ⅜" to 1" male pipe</li> </ul>

Note: Proper filtration is recommended to prevent damage to sealing surfaces.

### Terminology for ASME Safety Relief Valves

#### Safety Relief Valves

An automatic pressure relieving device actuated by the static pressure upstream of the valve, which opens in proportion to the increase over the opening pressure.

#### Start-to-Leak Pressure

The pressure at the valve inlet where the relieved fluid is first detected (on the downstream side of the seat) before normal relieving action takes place

#### Opening Pressure (Set Pressure)

The valve inlet pop point pressure at which there is a measurable lift or discharge becomes continuous as determined by seeing, hearing or feeling. In the pop type of safety valve, it is the inlet pressure at which the valve opens, allowing a larger

amount of fluid as compared with corresponding valve movements at higher or lower pressures

Note: A safety relief valve is not considered to open when it is simmering at a pressure just below the popping point even though the simmering may be audible. This set pressure distinguishes our ASME relief valves from our standard relief valves whose cracking pressure indicates initial flow.

#### Relieving Pressure

(Opening pressure plus overpressure) The pressure measured at the valve inlet at which the relieving capacity is determined.

#### Closing Pressure

(Reseat pressure) The pressure measured at the valve inlet, at which the valve closes,

flow is substantially shut off, and there is no measurable lift.

#### Seal-off Pressure

The pressure (measured at the valve inlet) after closing at which no further gas is detected at the downstream side of the seat.

#### Operating Pressure

The actual pressure at which a vessel is maintained in normal operation.

#### Accumulation

Pressure buildup or overpressure beyond the set pressure of a safety relief valve, at which capacity flow is rated. Capacities are usually based on 10% accumulation.

Note: Please specify 'ASME' when placing your order.

#### Circle Seal Controls

2301 Wardlow Circle • Corona, CA 92880-3300

Phone (951) 270-6200 Fax (951) 270-6201

www.circlesealcontrols.com • sales-circleseal@circor.com

relief valves

# ASME Safety Relief Valves

## Flow Curves

D500 Series

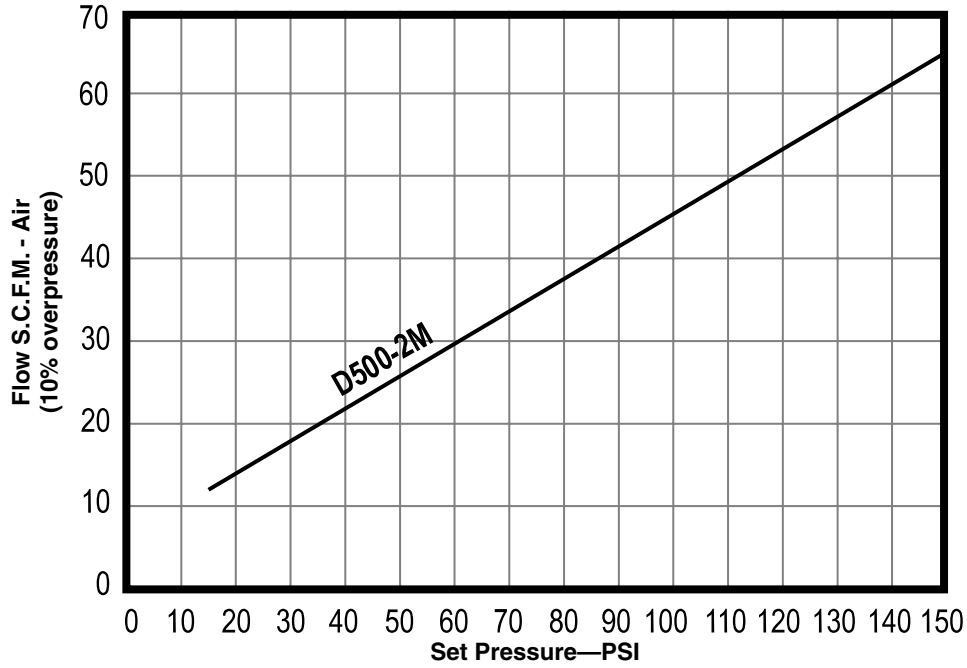

M5100 Series

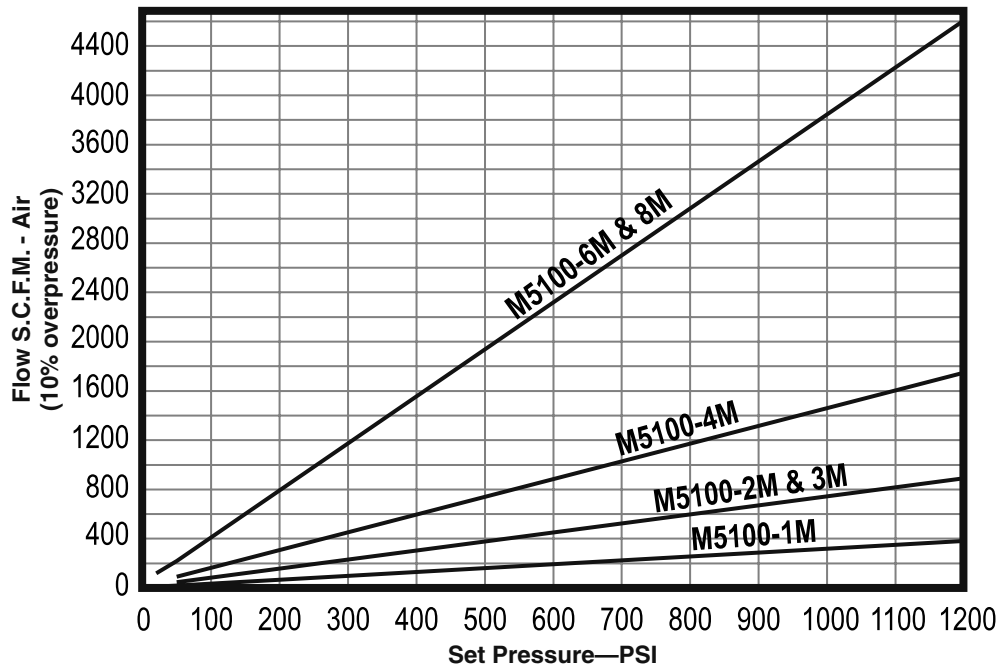

# ASME Safety Relief Valves

## How to Order: D500 Series ASME Relief Valves (15 to 150 psig)

**M D5 32 T1 - 2 M - 20**

**MANUAL OVERRIDE OPTION**

**O-RING MATERIAL & TEMPERATURE**

- 20** PTFE, -100° F to +400° F (-73°C to +204°C)
- 24** Silicone, -65° F to +150° F (-54°C to +66°C)
- 32** Viton®, -20° F to +350° F (-29°C to +177°C)
- 33** Neoprene, -20° F to +240° F (-29°C to +116°C)
- 59** Buna N, -20° F to +250° F (-29°C to +121°C)
- 62** Ethylene propylene, -20° F to +250° F (-29°C to +121°C)

**MATERIAL & OTHER PRESSURE BOUNDARY COMPONENTS**

- N** Naval brass
- T1** 316 stainless steel

**SET PRESSURE**

Specify set pressure in psig  
(15 – 150 psig)

**CONNECTIONS—INLET**

**M** Male pipe

**VALVE SIZE**

**2** ¼"

Please specify 'ASME' when placing your order.

To specify PED certification, add PED prefix to the part number.

Please consult your Circle Seal Controls distributor or our factory for information on special connections, lubricants, operating pressures and temperature ranges.

## Dimensions (inches)

Dash No.	Size	A	B Hex	C Dia.
-2M	¼"	1.1875	0.625	0.90

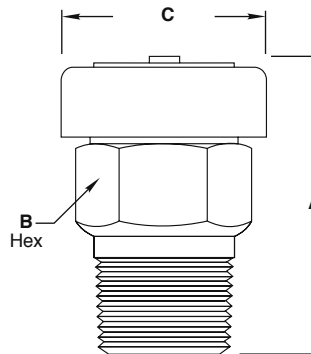

## Recommended Installation

1. Before installing a new safety relief valve, we recommend that a pipe tap be used to assure clean-cut and uniform threads in the vessel opening and to allow for normal hand engagement followed by a half to one turn by wrench.
2. Avoid over-tightening as this can distort the valve seat.
3. Avoid excess "popping" of the valve. Safety relief valves should only be operated often enough to assure they are in good working order.
4. Apply only a moderate amount of pipe compound or tape to the threads, leaving the first thread clean parts.
5. Don't oversize the valve, as this may cause chatter resulting in rapid wear of the moving parts.
6. Avoid wire, cable, or chain pulls for attachments to levers that do not allow a vertical pull. The weight of these devices should not be applied to the safety relief valve.
7. Avoid having the operation pressure too near the valve set pressure. A minimum differential of 10% is recommended.

## For Your Safety

It is solely the responsibility of the system designer and user to select products suitable for their specific application requirements and to ensure proper installation, operation, and maintenance of these products. Material compatibility, product ratings and application details should be considered in the selection. Improper selection or use of products described herein can cause personal injury or property damage.

Viton® is a registered trademark of DuPont Dow Elastomers.

# ASME Safety Relief Valves

## How to Order: M5100 Series ASME Relief Valves (20 to 1200 psig)

**M51 59 N - 4 M(L) - 20**

### O-RING MATERIAL & TEMPERATURE

- 20** PTFE, -100° F to +300° F (-73°C to +149°C)
- 32** Viton®, -20° F to +400° F (-29°C to +204°C)
- 33** Neoprene, -40° F to +250° F (-40°C to +121°C)
- 59** Buna N, -40° F to +250° F (-40°C to +121°C)
- 62** Ethylene propylene, -20° F to +200° F (-29°C to +93°C)

### BODY MATERIAL

- N** Naval brass
- T1** 316 stainless steel

### \* Set Pressure

- 1/8", 3/4", 1": 20 to 1200 psi (1 - 83 bar)
- 1/4", 3/8", 1/2": 50 to 1200 psi (3 - 83 bar)

Please specify 'ASME' when placing your order.

To specify PED certification, add PED prefix to the part number.

Please consult your Circle Seal Controls distributor or our factory for information on special connections, lubricants, operating pressures and temperature ranges.

## Dimensions (inches)

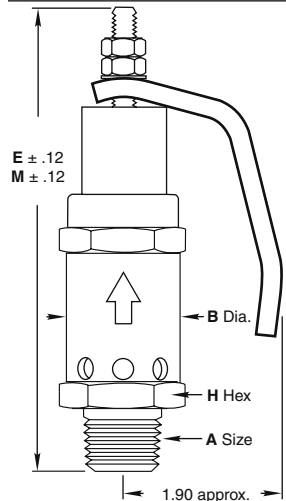

Dash No.	A Size	E	M	B Dia. H Hex
-1M	1/8"	2.84	3.45	0.71
-2M	1/4"	3.16	4.06	1.00
-3M	3/8"	3.19	4.09	1.00
-4M	1/2"	3.86	5.51	1.25
-6M	3/4"	5.41	7.54	1.50
-8M	1"	5.59	7.72	1.50

### Lift Handle

For 1/2", 3/4", and 1" valve sizes with set pressure of 451-1200 psi.

### Ring Handle

For set pressures to a maximum of 1200 psi in 1/8" through 3/8" valves sizes to a maximum of 450 psi in 1/2" through 1" sizes.

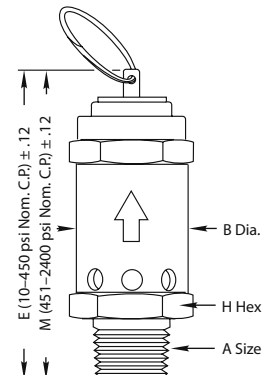

## Important

Complete part number MUST INCLUDE set pressure in psi. The ASME requires that valves be set at a "pop point". The ASME refers to this as the set pressure. This point is higher than the traditional Circle Seal Controls definition of cracking pressure.

After a prolonged period of storage with no system pressure, these relief valves will evidence an apparent high set pressure on first pop; therefore, in receiving inspection tests, true set pressure should be determined after first pop.

The following Circle Seal Controls valves have been tested in accordance with procedures in Paragraph UG 131, Section V111 of the ASME Unified Pressure Vessel Code:

- D500-2M      M5100-1M(L)    M5100-3M(L)    M5100-6M(L)
- M5100-2M(L)    M5100-4M(L)    M5100-8M(L)

ASME Certificate of Authorization, Number 4599

Note: These valves are not certified for steam or liquid service and are intended for air service applications only.

Viton® is a registered trademark of DuPont Dow Elastomers.

## For Your Safety

It is solely the responsibility of the system designer and user to select products suitable for their specific application requirements and to ensure proper installation, operation, and maintenance of these products. Material compatibility, product ratings and application details should be considered in the selection. Improper selection or use of products described herein can cause personal injury or property damage.

## 5300 Series

### Relief Valves

400 to 10,500 psig (28 – 724 bar)



### Features

- Zero leakage up to 95% of cracking pressure
- No chatter or squeal
- Positive reseal at a high percentage of cracking pressure
- No pressure rise with increasing flow
- Externally adjustable
- PED certifications and CE marking available for most models

### Technical Data

<b>Body Construction Materials</b>	Brass, 303 or 316 stainless steel
<b>O-ring Materials</b>	Buna N, neoprene, and Viton®
<b>Poppet Materials</b>	<ul style="list-style-type: none"> <li>• Liquid service: CRES 440C</li> <li>• Gas service to 3074 psi: PCTFE</li> <li>• Gas service above 3074 psi: Polyimide (Vespel®)</li> </ul>
<b>Retainer Stem</b>	303 stainless steel
<b>Seat Material</b>	17-4 PH stainless steel
<b>Spring Material</b>	17-7 PH stainless steel
<b>Backup Rings</b>	PTFE
<b>Operating Pressure</b>	400 to 10,500 psig (28 to 724 bar); specify cracking pressure
<b>Proof Pressure</b>	<ul style="list-style-type: none"> <li>• Gas: 4500 psig (PCTFE); 10,500 psig (Polyimide)</li> <li>• Liquid: 16,000 psig</li> </ul>
<b>Burst Pressure</b>	<ul style="list-style-type: none"> <li>• Brass: over 30,000 psig (2068 bar)</li> <li>• Stainless steel: over 40,000 psig (2758 bar)</li> </ul>
<b>Temperature Range</b>	-65° F to +350° F (-54° C to +177° F) <i>Based on O-ring &amp; body material, see "How to Order"</i>
<b>Connection Sizes</b>	<ul style="list-style-type: none"> <li>• ¼" to ½" female pipe</li> <li>• ¼" to 1" female tube</li> </ul>

Note: Proper filtration is recommended to prevent damage to sealing surfaces.

### How it Works

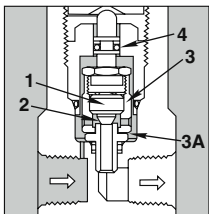

#### Closed

In the closed position, the poppet (1) is impressed against the orifice (2) by the spring and seals of the orifice. This impression is limited by the poppet retainer (3) which bottoms on the shoulder of the orifice nozzle unit at point 3A. As system pressure rises, pressure within the poppet retainer and above the poppet increases, effecting further sealing efficiency. As pressure rises above normal operating pressure, the poppet retainer (3) moves upward overcoming breakaway friction of the O-ring seal (4) before the preset cracking pressure is reached. This insures extremely precise cracking pressure accuracy.

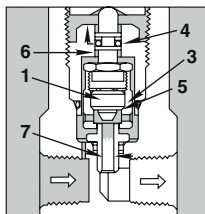

#### Cracking

When system pressure rises above the cracking pressure, the force at area 6 is increased and overcomes the preset spring force, permitting the poppet retainer (3) to continue its upward movement and lift the poppet (1) away from the orifice (5), permitting flow through the orifice passage (7).

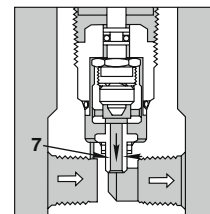

#### Open

Under conditions of flow, back pressure in the orifice nozzle (7) reduces the effective downward force on the poppet, which allows the poppet retainer unit to open further, providing increased flow with little or no increase in pressure. Where the valve is used as a sequence or priority valve, the downstream pressure buildup permits the poppet to open fully, allowing flow with minimum pressure drop.

relief valves

### Circle Seal Controls

2301 Wardlow Circle • Corona, CA 92880-3300

Phone (951) 270-6200 Fax (951) 270-6201

www.circlesealcontrols.com • sales-circleseal@circor.com

# 5300 Series

**Cracking Pressure Tolerance:**  $\pm 5\%$

**Flow at cracking pressure:** Gas = 5cc/min  
PTFE seals = 0.02 scfm

## Reseal pressure

### Crack Pressure      Reseal Pressures

400–599 psi	80% of C.P.
600–899 psi	85% of C.P.
900–5999 psi	90% of C.P.
6000 psi & greater	95% of C.P.

### Leakage at reseal pressure

Gas	Ascending pressure = zero to 95% of cracking pressure
	Descending pressure = zero at reseal
Liquid	Ascending pressure = 5cc/min maximum to 95% of cracking pressure
	Descending pressure = 15cc/min maximum at reseal

## Dimensions (inches)

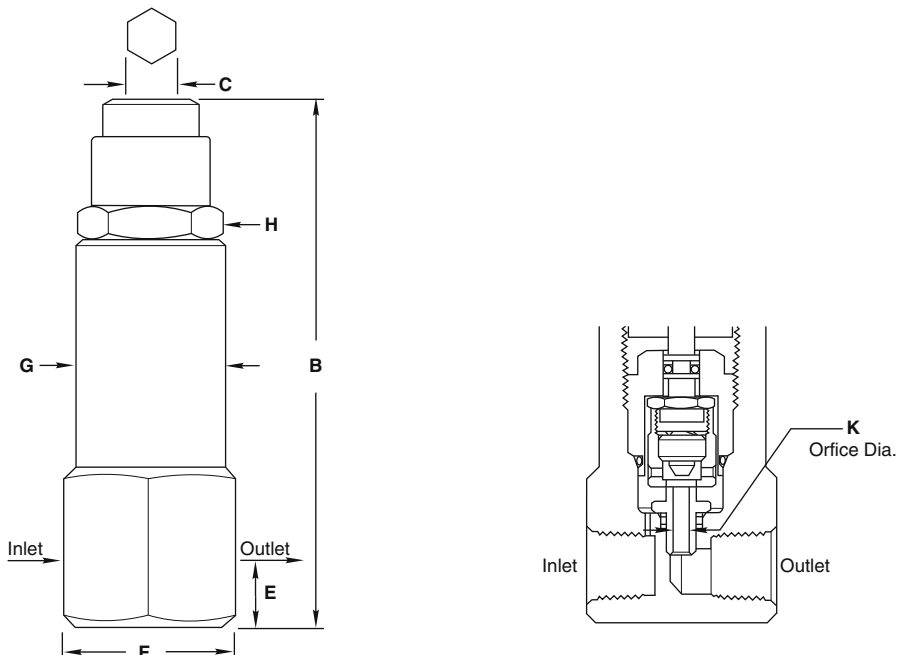

Tube Size	C.P. Range (PSI)	B Max.	C Hex	E	F Hex	G Dia.	H Hex	K Dia.	Weight (lbs)	
									Brass	Stainless Steel
1/4", 3/8"	420–3074	4.88	1/2	0.52	1.63	1.38	1.25	0.125	1.6	1.5
	3075–10,500	5.78	3/8	0.52	1.63	1.38	1.25	0.125	1.8	1.7
1/2"	420–3074	4.88	1/2	0.70	1.88	1.38	1.25	0.125	1.6	1.5
	3075–10,500	5.78	3/8	0.70	1.88	1.38	1.25	0.125	1.8	1.7
3/4"	400–2299	7.01	5/16	0.94	2.50	1.75	1.50	1.88	—	—
	2300–10,500	8.48	1/2	0.94	2.50	1.75	1.50	1.88	—	—
1"	400–2299	7.01	5/16	0.94	3.00	1.75	1.50	1.88	—	—
	2300–10,500	8.48	1/2	0.94	3.00	1.75	1.50	1.88	—	—

Pipe Size	C.P. Range (PSI)	B Max.	C Hex	E	F Hex	G Dia.	H Hex	K Dia.	Weight (lbs)	
									Brass	Stainless Steel
1/4"	420–3074	4.88	1/2	0.52	1.50	1.38	1.25	0.125	1.6	1.5
	3075–10,500	5.78	3/8	0.52	1.50	1.38	1.25	0.125	1.8	1.7
1/2"	400–2299	7.01	5/16	0.82	2.00	1.75	1.50	0.188	3.2	3.0
	2300–10,500	8.48	1/2	0.82	2.00	1.75	1.50	0.188	3.7	3.5

# 5300 Series

## Typical Flow Curves

5300-4PP with Hydraulic Fluid  
MIL-H-5606

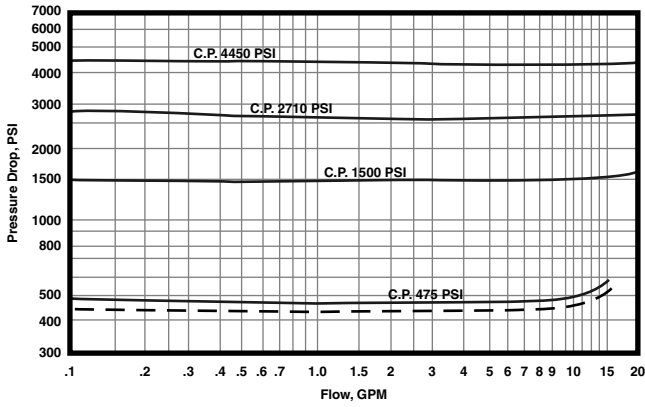

5300-4PP with Air

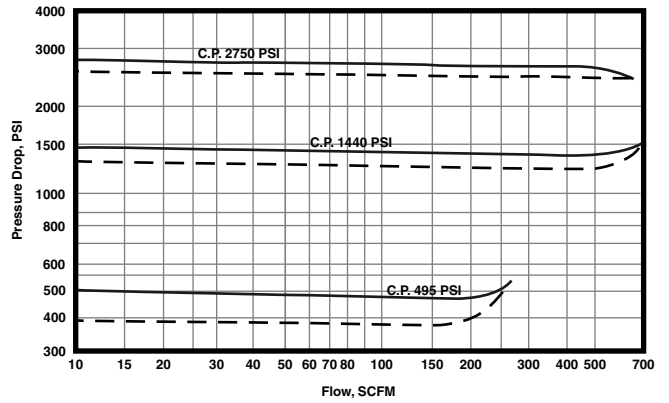

5300-8BB, 5300-2BB with Hydraulic Fluid  
MIL-H-5606

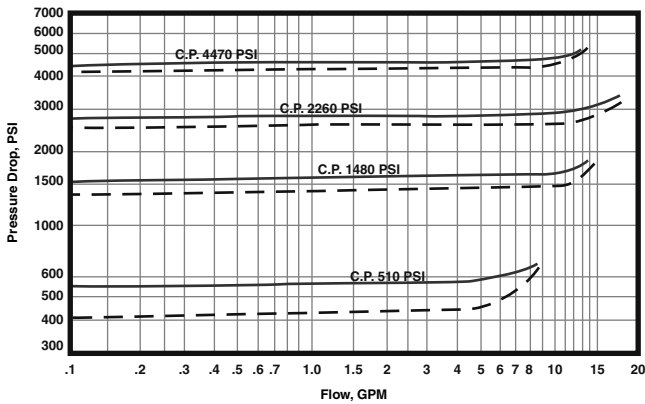

5300-8PP, 5300-2PP with Air

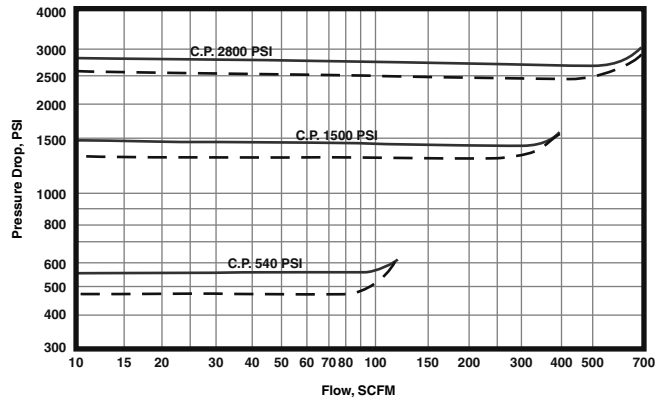

Increasing flow ———

Decreasing flow - - - - -



# 5300 Series

## How to Order

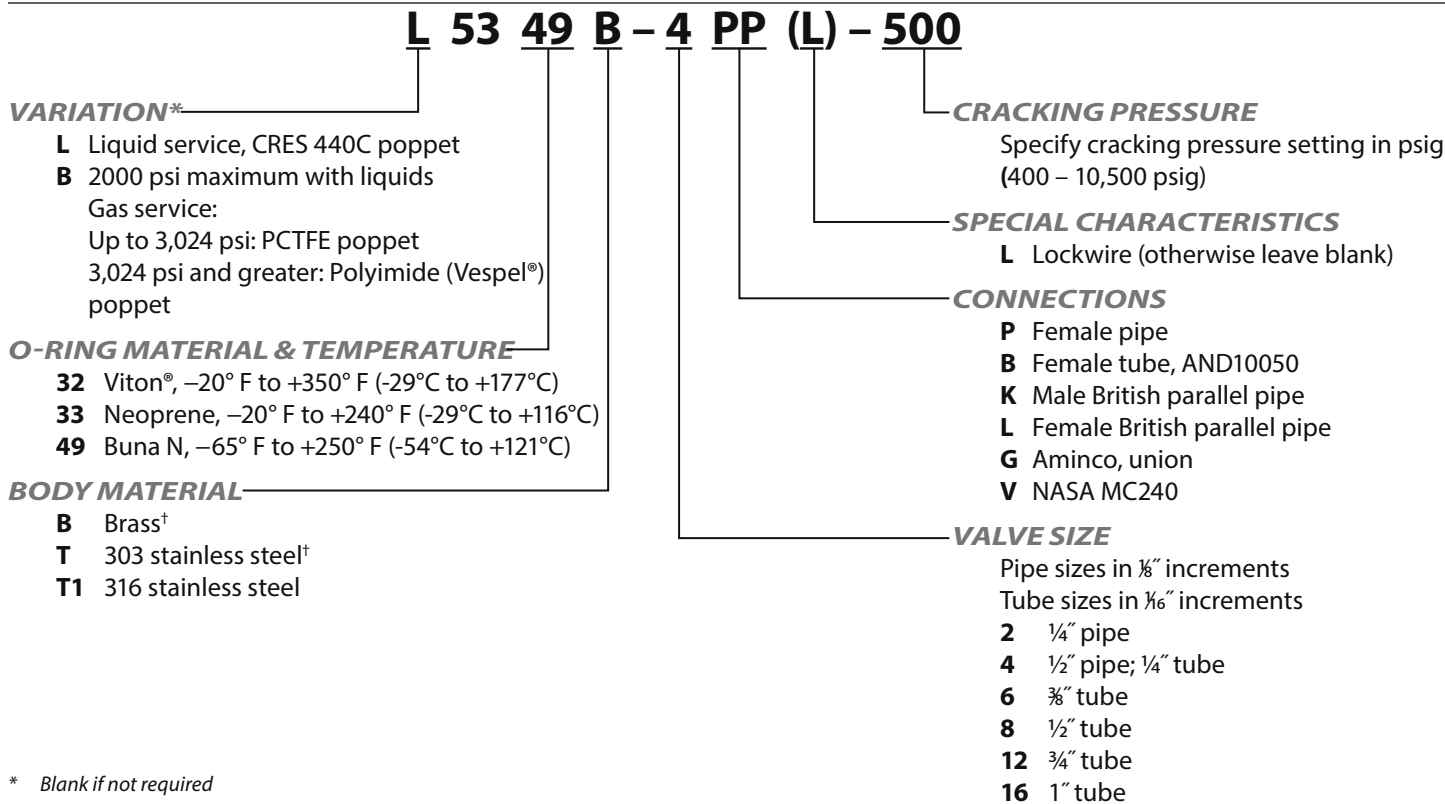

\* Blank if not required

† For PED applications, bodies are limited to a maximum temperature use of +100° F (+38° C)

To specify PED certification, add PED prefix to the part number.

Back pressure: Any back pressure above atmosphere reduces the cracking pressure by 0.35 psi for each 1.0 psi of back pressure.

### Repair Kits

In normal service, the only part(s) which may require replacement is(are) the seal(s). A repair kit may be ordered by placing a 'K/' in front of the complete part number (i.e. K/5349B-4PP).

### Cracking Pressure Spring Ranges

Consult factory for replacement spring part numbers

Dash No. (Valve Size)	C.P. Range	Dash No. (Valve Size)	C.P. Range
	400-599		420-589
	600-899		590-839
	900-1299		840-1179
-4PP (1/2")	1300-1799	-2PP (1/4")	1180-1574
-12BB (3/4")	1800-2299	-4BB (1/4")	1575-1899
-16BB (1")	2300-3299	-6BB (3/8")	1900-2449
	3300-6999	-8BB (1/2")	2450-3074
	7000-10,500		3075-3999
			4000-7399
			7800-10,500

### For Your Safety

It is solely the responsibility of the system designer and user to select products suitable for their specific application requirements and to ensure proper installation, operation, and maintenance of these products. Material compatibility, product ratings and application details should be considered in the selection. Improper selection or use of products described herein can cause personal injury or property damage.

Viton® is a registered trademark of DuPont Dow Elastomers.

Vespel® is a registered trademark of E.I. du Pont de Nemours and Company.



Available in low, medium, high and extra high pressure models, R6000 right angle relief valves provide users with high accuracy and consistency of cracking and reseal pressures. Furthermore, narrow pressure ranges (cracking pressures) for each model can be factory pre-set according to customer specifications. PED certification and CE marking are standard for all models. All R6000 relief valves are offered with multiple end connections to ensure application versatility.

## Typical Applications

- Beverage dispensing equipment
- Gas pilot plants
- Petrochemical test labs
- Offshore oil platform heating lines
- Pharmaceutical sterilization and packaging systems

## Circle Seal Controls

2301 Wardlow Circle • Corona, CA 92880-3300  
 Phone (951) 270-6200 Fax (951) 270-6201  
 www.circlesealcontrols.com • sales-circleseal@circor.com

## Features & Benefits

### Low Pressure (5 – 550 psig)\*

#### Zero friction poppets

- Increases accuracy of cracking pressure and reseal pressure.
- Improves consistency of cracking pressure and reseal pressure.

#### Encapsulated Seat Seal

- Maintains small contact surface area.
- Protects seat from erosion due to flow.

Raised seal lip on poppet minimizes contact with seat, eliminating friction and preventing overstressing of the O-ring

6 pressure spring ranges improve accuracy

Caps and bonnets are pre-drilled for lockwire

Multiple end connections available

### High Pressure (150–6000 psig)

#### 3 models available:

- Medium (150–2500 psig)—6 spring ranges improve accuracy
- High (150–5000 psig)—7 spring ranges improve accuracy
- Extra High (5000–6000 psig)—one spring

Delta stem seal design prevents friction which increases accuracy of cracking pressure and reseal pressure.

Balanced poppet design allows cracking pressure to stay the same regardless of backup pressure.

Orifice sizes: 0.082", 0.094", 0.188"

Multiple end connections available.

Optional manual override handle

For European Pressure Equipment Directive (PED 97/23/EC) applications, due to the R6000 valve's small poppet seat design, it is imperative that the R6000 valve be used in clean gas service ONLY (free from dust particles, contamination, and etc. (gas group 1 & 2)).

\*Back pressure affects cracking pressure on low pressure version

relief valves

# R6000 Series

## Materials of Construction

LR	
1	End
2	Body
3	Shroud ring
4	Poppet
5	Bonnet
6	Jam nut
7	Cap
8	Spring holder
9	Retaining ring
10	O-ring
11	Spring
12	Spring equalizer
13	O-ring
14	Seat O-ring
15	O-ring

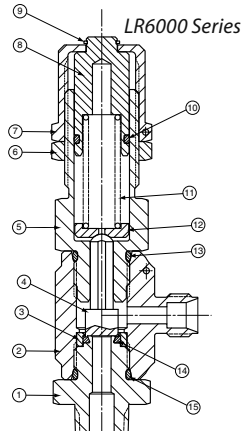

MR/HR/XR	
1	End
2	Body
3	Shroud ring
4	Poppet
5	Bonnet
6	Jam nut
7	Cap
8	Spring holder
9	Spring
10	Spring equalizer
11	O-ring
12	Delta ring
13	O-ring
14	Seat O-ring
15	O-ring

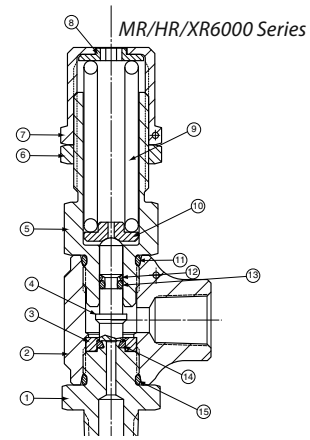

Specifications	
<b>BODY CONSTRUCTION</b>	316 stainless steel
<b>SPRING MATERIAL</b>	17-7PH CRES
<b>SEAL MATERIAL</b>	Neoprene • Viton® • Buna N • EPR • Kalrez® • Silicone (not available for the XR Series)
<b>CONNECTION SIZES</b>	1/4"
<b>ORIFICE SIZE</b>	LR6000, MR6000: 0.188" HR6000: 0.094" XR6000: 0.082"

## Dimensions

Model No.	1/4" GYROLOK® x 1/4" GYROLOK®			1/4" Male NPT x 1/4" GYROLOK®			1/4" Male NPT x 1/4" Female NPT		
	A	B	C	D	E	F	G	H	J
LR	3.10" max (7.87cm)	1.34" (3.40cm)	0.97" (2.39cm)	3.10" max (7.87cm)	1.44" (3.66cm)	0.97" (2.39cm)	n/a	1.44" (3.66cm)	1.00" (2.54cm)
MR	2.94" max. (7.47cm)	1.34" (3.40cm)	0.97" (2.39cm)	2.94" max. (7.47cm)	1.44" (3.66cm)	0.97" (2.39cm)	2.94" max. (7.47cm)	1.44" (3.66cm)	1.00" (2.54cm)
HR	2.94" max. (7.47cm)	1.34" (3.40cm)	0.97" (2.39cm)	2.94" max. (7.47cm)	1.44" (3.66cm)	0.97" (2.39cm)	2.94" max. (7.47cm)	1.44" (3.66cm)	1.00" (2.54cm)
XR	2.94" max. (7.47cm)	1.34" (3.40cm)	0.97" (2.39cm)	2.94" max. (7.47cm)	1.44" (3.66cm)	0.97" (2.39cm)	n/a	1.44" (3.66cm)	1.00" (2.54cm)

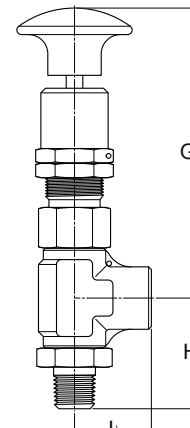
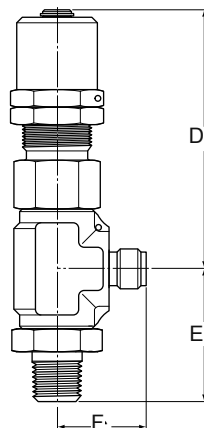
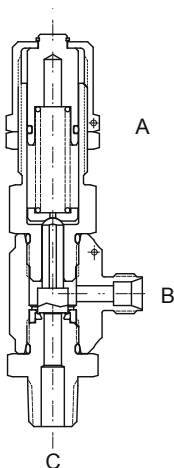

# R6000 Series

## Operating Pressures

Pressures	LR6000	MR6000	HR6000	XR6000
Cracking Pressure	5–550 psig (0–38 bar)	150–2500 psig (10–172 bar)	150–5000 psig (10–345 bar)	5000–6000 psig (345–414 bar)
Maximum Operating Pressure	5–700 psig (0–48 bar)	150–6000 psig (10–414 bar)	150–7000 psig (10–482 bar)	5000–7000 psig (345–482 bar)
Proof	1050 psig (72 bar)	9000 psig (620 bar)	9000 psig (620 bar)	9000 psig (620 bar)
Burst	Over 2800 psig (193 bar)	Over 24,000 psig (1652 bar)	Over 24,000 psig (1652 bar)	Over 24,000 psig (1652 bar)
Reseat Pressure	85% min. of CP > 10 psig 70% of CP < 10 psig	85% min. of CP	85% min. of CP	85% min. of CP

## Cv Ratings

Cracking Pressure	C <sub>v</sub> LR6000 0.188"		C <sub>v</sub> MR6000 0.188"		C <sub>v</sub> HR6000 0.094"		C <sub>v</sub> XR6000 0.082"	
	Air	Water	Air	Water	Air	Water	Air	Water
PSIG								
5	0.63	0.47	—	—	—	—	—	—
25	0.63	0.47	—	—	—	—	—	—
26	0.64	0.43	—	—	—	—	—	—
80	0.64	0.43	—	—	—	—	—	—
81	0.4	0.31	—	—	—	—	—	—
150	0.4	0.31	—	—	—	—	—	—
151	0.42	0.26	0.79	0.59	0.25	0.16	—	—
250	0.42	0.26	0.79	0.59	0.25	0.16	—	—
251	0.3	0.19	0.79	0.59	0.25	0.16	—	—
350	0.3	0.19	0.79	0.59	0.25	0.16	—	—
351	0.35	0.18	0.61	0.59	0.27	0.16	—	—
550	0.35	0.18	0.61	0.59	0.27	0.16	—	—
650	—	—	0.61	0.59	0.27	0.16	—	—
651	—	—	0.38	0.29	0.27	0.16	—	—
700	—	—	0.38	0.29	0.27	0.16	—	—
701	—	—	0.38	0.29	0.2	0.16	—	—
1001	—	—	0.37	0.20	0.2	0.14	—	—
1300	—	—	0.37	0.20	0.2	0.14	—	—
1301	—	—	0.37	0.20	0.21	0.14	—	—
1500	—	—	0.37	0.20	0.21	0.13	—	—
1501	—	—	0.28	0.14	0.21	0.13	—	—
2000	—	—	0.28	0.14	0.21	0.13	—	—
2001	—	—	0.24	0.10	0.19	0.13	—	—
2500	—	—	0.24	0.10	0.19	0.13	—	—
3000	—	—	—	—	0.19	0.13	—	—
3001	—	—	—	—	0.15	0.07	—	—
4000	—	—	—	—	0.15	0.07	—	—
5000	—	—	—	—	—	—	0.15	0.009
6000	—	—	—	—	—	—	0.12	0.006

# R6000 Series

## Pressure/Temperature Ratings

### Low Pressure

Valve No.	Seal Material	Temperature °F (°C)	Pressure Range psig (bar)
LR6033	Neoprene	-40° to +300° (-40° to +149°)	Up to 25 (Up to 1.7) 26–350 (1.8–24.1) 351–550 (24.2–37.9)
LR6032	Viton®	-20° to +400° (-29° to +204°)	Up to 25 (Up to 1.7) 26–350 (1.8–24.1) 351–550 (24.2–37.9)
LR6077	Buna-N	-65° to +275° (-54° to +135°)	Up to 25 (Up to 1.7) 26–350 (1.8–24.1) 351–550 (24.2–37.9)
LR6062	Ethylene Propylene	-65° to +300° (-54° to +149°)	Up to 25 (Up to 1.7) 26–350 (1.8–24.1) 351–550 (24.2–37.9)
LR6065	Kalrez®	-40° to +550° (-40° to +288°)	Up to 25 (Up to 1.7) 26–350 (1.8–24.1) 351–550 (24.2–37.9)
LR6024	Silicone	-70° to +450° (-57° to +232°)	Up to 25 (Up to 1.7) 26–350 (1.8–24.1) 351–550 (24.2–37.9)

### Medium Pressure

Valve No.	Seal Material	Temperature °F (°C)	Pressure Range psig (bar)
MR6033	Neoprene	-40° to +300° (-40° to +149°)	150–350 (10.3–24.1) 351–2500 (24.2–172.4)
MR6032	Viton®	-20° to +400° (-29° to +204°)	150–350 (10.3–24.1) 351–2500 (24.2–172.4)
MR6077	Buna-N	-65° to +275° (-54° to +135°)	150–350 (10.3–24.1) 351–2500 (24.2–172.4)
MR6062	Ethylene Propylene	-65° to +300° (-54° to +149°)	150–350 (10.3–24.1) 351–2500 (24.2–172.4)
MR6065	Kalrez®	-40° to +550° (-40° to +288°)	150–350 (10.3–24.1) 351–2500 (24.2–172.4)
MR6024	Silicone	-70° to +450° (-57° to +232°)	150–350 (10.3–24.1)

### High Pressure

Valve No.	Seal Material	Temperature °F (°C)	Pressure Range psig (bar)
HR6033	Neoprene	-40° to +300° (-40° to +149°)	150–300 (10.3 to 20.7) 301–5000 (20.8 to 344.8)
HR6032	Viton®	-20° to +400° (-29° to +204°)	150–300 (10.3 to 20.7) 301–5000 (20.8 to 344.8)
HR6077	Buna-N	-65° to +275° (-54° to +135°)	150–300 (10.3 to 20.7) 301–5000 (20.8 to 344.8)
HR6062	Ethylene Propylene	-65° to +300° (-54° to +149°)	150–300 (10.3 to 20.7) 301–5000 (20.8 to 344.8)
HR6065	Kalrez®	-40° to +550° (-40° to +288°)	150–300 (10.3 to 20.7) 301–5000 (20.8 to 344.8)
HR6024	Silicone	-70° to +450° (-57° to +232°)	150–300 (10.3 to 20.7)

### Extra High Pressure

Valve No.	Seal Material	Temperature °F (°C)	Pressure Range psig (bar)
XR6033	Neoprene	-40° to +300° (-40° to +149°)	5000–6000 (344.8–413.8)
XR6032	Viton®	-20° to +400° (-29° to +204°)	5000–6000 (344.8–413.8)
XR6077	Buna-N	-65° to +275° (-54° to +135°)	5000–6000 (344.8–413.8)
XR6062	Ethylene Propylene	-65° to +300° (-54° to +149°)	5000–6000 (344.8–413.8)
XR6065	Kalrez®	-40° to +550° (-40° to +288°)	5000–6000 (344.8–413.8)

# R6000 Series

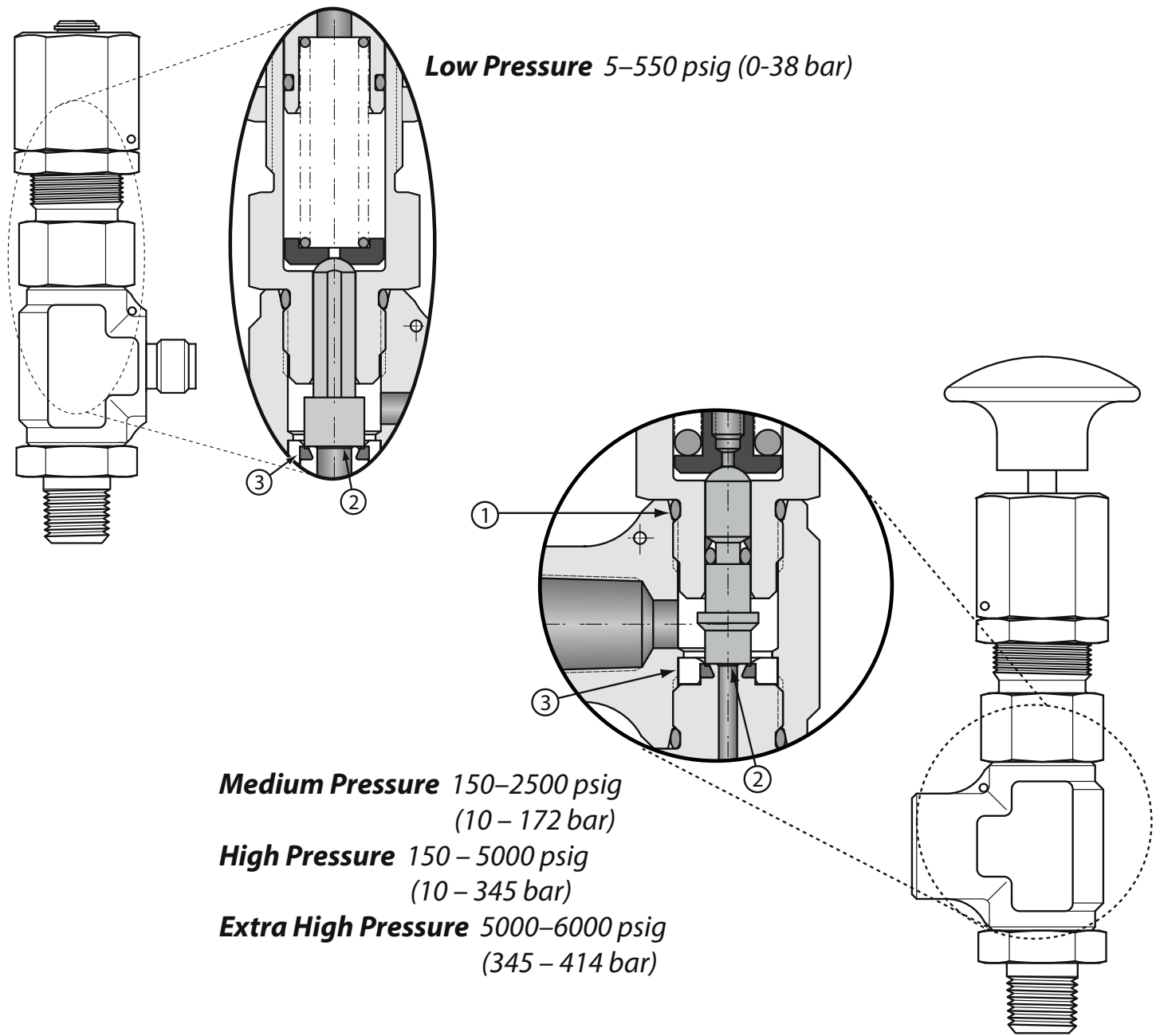

## Features

① O-ring & Delta backup ring

② Raised seal lip

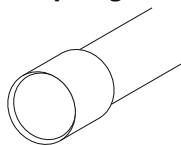

③ Fully encapsulated seat seal

# R6000 Series

## Crack Pressure Range

Select appropriate spring code

LR6000 Low Pressure		MR6000 Medium Pressure		HR6000 High Pressure		XR6000 Extra High Pressure	
Spring Code	Range in PSIG (BAR)	Spring Code	Range in PSIG (BAR)	Spring Code	Range in PSIG (BAR)	Spring Code	Range in PSIG (BAR)
A	5-25 (0-2)	B	150-350 (10-24)	A	150-300 (10-21)	A	5000-6000 (345-414)
B	26-80 (2-6)	C	351-650 (24-45)	B	301-700 (21-48)		
C	81-150 (6-10)	D	651-1000 (45-69)	C	701-1300 (48-90)		
D	151-250 (10-17)	E	1001-1500 (69-103)	D	1301-2000 (90-138)		
E	251-350 (17-24)	F	1501-2000 (104-138)	E	2001-3000 (138-207)		
F	351-550 (24-38)	G	2001-2500 (138-172)	F	3001-4000 (207-276)		
				G	4001-5000 (276-345)		

## How to Order

**LR60 24 - 2MP - A C M - \* \* \* \***

### BASIC MODEL NUMBER

- LR60** Low pressure  
5-550 psig (0-38 bar)
- MR60** Medium pressure  
150-2500 psig (10-172 bar)
- HR60** High pressure  
150-5000 psig (10-276 bar)
- XR60** Extra high pressure  
5000-6000 psig  
(345-414 bar)

### SEAL MATERIAL

- 24** Silicone\*
- 32** Viton®
- 33** Neoprene
- 62** Ethylene propylene
- 65** Kalrez®
- 77** Buna-N

### MANUAL OVERRIDE

(optional, not available for LR or XR series)  
MR series only available up to 350 psig (24 bar).  
HR series only available up to 700 psig (48 bar).

### CIRCLE SEAL CONTROLS

### SPRING CODE

See Crack Pressure Range table above

### PORT SIZE

	Inlet	Outlet
<b>2MP</b>	¼" male NPT	¼" female NPT
<b>2M4G</b>	¼" male NPT	¼" GYROLOK®
<b>4G</b>	¼" GYROLOK®	¼" GYROLOK®
<b>2RT</b>	¼" male BSPT	¼" female BSPT
<b>6Z</b>	6mm GYROLOK®	6mm GYROLOK®
<b>8Z</b>	8mm GYROLOK®	8mm GYROLOK®
<b>12Z</b>	12mm GYROLOK®	12mm GYROLOK®

R6000 valves are CE 0035 / PED approved

- \* Silicone seals are not available for XR series.
- \* Silicone seals for MR series only available up to 350 psig (spring code B)
- \* Silicone seals for HR series only available up to 300 psig (spring code A)

\*\*\*\* Customer can request a specific cracking pressure when ordering. To specify, add the cracking pressure as -PSIG (not BAR) after the M for Manual Override (if no override, add value after "C"). Otherwise, the factory sets the valve at the nominal midpoint of the cracking pressure range selected. Valves with specific cracking pressure come standard with factory installed lockwire.

## R6000 Service Kits

LR Kit includes: end seat-to-body O-ring, bonnet-to-body O-ring, and bonnet seal O-ring.

MR/HR/XR Kit includes: end seat-to-body O-ring, bonnet-to-body O-ring, seat O-ring, and Delta seal. Replacement of Delta seal requires use of installation tool and resizing tool. Consult factory for details.

To Order, add K to front of valve part number (example: KLR6024-2MP-AC).

## For Your Safety

It is solely the responsibility of the system designer and user to select products suitable for their specific application requirements and to ensure proper installation, operation, and maintenance of these products. Material compatibility, product ratings and application details should be considered in the selection. Improper selection or use of products described herein can cause personal injury or property damage.

GYROLOK® is a registered trademark of HOKE®.

Kalrez® and Viton® are registered trademarks of DuPont Dow Elastomers.

www.hoke.com

www.dupont-dow.com

# Relief Valve Specification Check Sheet

## Customer Information

Customer Name	
Company Name	
Address	
Telephone	Fax
E-mail	

## Application Information

Application	
Maximum Operating Pressure	PSIG / BAR (circle one)
Operating Temperature Max:	°F / °C (circle one) Min: °F / °C (circle one)
System Fluid(s)	
Cracking Pressure (Set)	psig / BAR (circle one)
<i>Note: Standard cracking pressure is defined as a flow of 5cc/min for elastomers, 0.02 scfm (600cc) for PTFE</i>	
Minimum Reseat Pressure	psig / BAR (circle one) Allowable Leakage at Reseat
Flow Rate (Min)	SCFM / GPM at Maximum Pressure Drop

## Valve Information

### Materials

Body	Trim	Seat
------	------	------

### Line Connections

Inlet Size	Type
Outlet Size	Type

### Envelope Requirements

L	W	H
---	---	---

Maximum Weight
----------------

Units Must Meet the Following Specifications
--

--

--

Number of Units Required:	Now	Yearly
---------------------------	-----	--------

Target Price
--------------







The Small Bore  
Instrumentation Specialists



The Circle Seal Controls Brand is just one product offering manufactured and supplied by CIRCOR Instrumentation (CI) a division of CIRCOR International (NYSE:CIR).

CI is a global manufacturer that specializes in developing highly engineered, technically superior small bore instrumentation solutions that consistently deliver benchmark performance, quality & safety for general-to-severe service liquid & gas flow applications.

We specialize in small bore instrumentation products up to 2" that deliver benchmark performance quality & safety; provide the broadest array of superior alloy offerings in the market; decades of proven success in a wide range of industries; a roster of "who's who" customers & projects globally; original "Best Solution" engineering & designs; and are focused on continuous improvement in all aspects of our business.

**CIRCOR Instrumentation headquarters:**

PO Box 4866  
Spartanburg, SC 29305-4866  
+1-864-574-7966  
+1-864-587-5608 (Fax)

**Circle Seal Controls manufacturing facilities:**

2301 Wardlow Circle  
Corona, CA 92880-2881  
Phone (951) 270-6200  
Fax (951) 270-6201

[www.circlesealcontrols.com](http://www.circlesealcontrols.com)  
[sales-circleseal@circor.com](mailto:sales-circleseal@circor.com)

**Proudly Distributed By:**

