

HOKE® Condensed Catalog

Index

Safety Warning	Inside Front Cover
Needle Valves	1
Metering Valves	3
Ball Valves	4
Actuated Ball Valve Packages	7
Plug Valves	8
Fluid Control Components	9
Packless Valves	11
Manifolds	13
Sampling Cylinders	14
Analytical Products	15
GYROLOK®	
Features and Benefits	16
General Information	17
Pipe Thread Information	17
Tube Fittings at a Glance	18

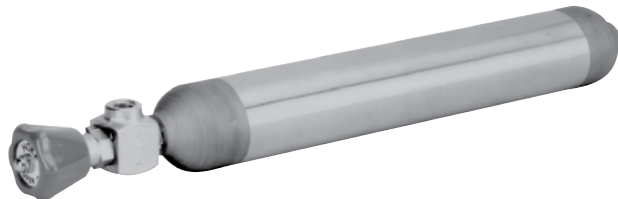
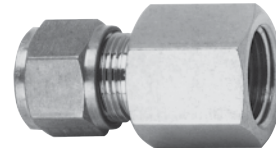
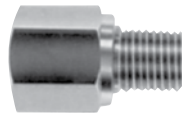
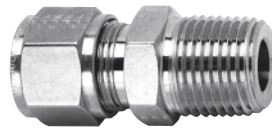
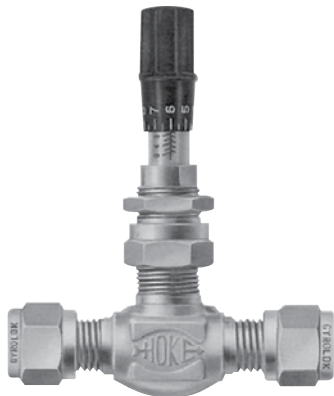

condensed catalog



CRANE Instrumentation & Sampling, HOKE®
 PO Box 4866 • Spartanburg, SC 29305-4866
 (864) 574-7966 • www.hoke.com

For Your Safety

It is solely the responsibility of the system designer and user to select products suitable for their specific application requirements and to ensure proper installation, operation, and maintenance of these products. When selecting products, the total system design must be considered to ensure safe, trouble-free performance. Material compatibility, product ratings and application details should be considered in the selection. Improper selection or use of products described herein can cause personal injury or property damage.

Contact your authorized HOKE® sales and service representative for information about additional sizes and special alloys.

SAFETY WARNING:

HOKE® products are designed for installation only by professional suitably qualified licensed system installers experienced in the applications and environments for which the products are intended. These products are intended for integration into a system. Where these products are to be used with flammable or hazardous media, precautions must be taken by the system designer and installer to ensure the safety of persons and property. Flammable or hazardous media pose risks associated with fire or explosion, as well as burning, poisoning or other injury or death to persons and/or destruction of property. The system designer and installer must provide for the capture and control of such substances from any vents in the product(s). The system installer must not permit any leakage or uncontrolled escape of hazardous or flammable substances. The system operator must be trained to follow appropriate precautions and must inspect and maintain the system and its components including the product(s) and at regular intervals in accordance with timescales recommended by the supplier to prevent unacceptable wear or failure.

Needle Valves

Forged Body Needle Valves 1700 Series



Applications:

- Cylinder valves
- Panel board instrumentation
- Pilot plants for corrosive liquids and high pressures
- Research laboratories

Maximum Operating Pressure:

- 6000 psig @ 70° F
(414 barg @ 21° C)

Operating Temperature Range:

- -65° F to +450° F (-54° C to +232° C)

Orifice Size:

- .187" (4.8 mm)

C_v Factors:

- .31

Features:

- Choice of 316 stainless steel or MONEL®
- Choice of metal or plastic handle
- Dyna-Pak® packing below stem threads provides leak-tight service
- Non-rotating stem point prevents galling and extends valve life
- Hardened thread gland provides long cycle life

Bar Stock Needle Valves 2100 Series



Applications:

- Hydraulic systems
- High temperature service to 600° F
- Gas sampling
- Test stands

Maximum Operating Pressure:

- 6000 psig @ 70° F
(414 barg @ 21° C)

Operating Temperature Range:

- -65° F to +600° F (-54° C to +316° C)

Orifice Sizes:

- .188" to .313" (4.8 mm to 8.0 mm)

C_v Factors:

- .40 to 1.20

Features:

- Variety of materials—brass, 316 stainless steel, carbon steel
- Choice of all-metal stem point or non-rotating replaceable PCTFE tip for long seat life
- Choice of Dyna-Pak® packing or high temperature packing to 600° F (316° C)
- 1/8" to 1/2" end connections

Bar Stock Needle Valves 2200 Series



Applications:

- Corrosive handling
- Sampling systems
- Metering service

Maximum Operating Pressure:

- 5000 psig @ 70° F
(345 barg @ 21° C)

Operating Temperature Range:

- -65° F to +450° F (-54° C to +232° C)

Orifice Sizes:

- .086" to .313" (2.2 mm to 8.0 mm)

C_v Factors:

- .12 to 1.40

Features:

- Corrosion-resistant 316 stainless steel
- Dyna-Pak® packing below stem threads prevents thread lubricant wash out
- Vee-point stem option for moderate metering
- HASTELLOY® C-276 stem point

Needle Valves

Severe Service Needle Valves 2219 Series

Applications:

- Steam service in power plants
- Hot condensates

Maximum Operating Pressure:

- 6000 psig @ 70° F (414 barg @ 21° C)

Operating Temperature Range:

- -100° F to + 1000° F @ 1750 psig max.
-75° C to + 538° C @ 120 bar max.

Orifice Sizes:

- 0.170", 0.250", 0.312", and 0.437"
(4.3mm, 6.4mm, 7.9mm, and 11.1mm)

C_v Factors*:

- 0.47, 1.09, and 1.20

Features:

- Designed for high pressure / high temperature use
- Meets ANSI 900# specifications
- Grafoil® packing below threads isolates threads from media.
- Non-rotating stem tip prevents galling
- Bubble-tight leak testing at both seat and packing
- Leak-tight fractional end connections available up to 1"; metric end connections up to 25mm

* C_v factor for 0.437" orifice not available at time of publication



Needle Valves for Sour Gas Service 2700 Series

Applications:Maximum Operating

- Refineries
- Chemical processing
- Oil & Gas drilling

Maximum Operating Pressure:

- 6000 psig @ 70° F
(414 barg @ 21° C)

Operating Temperature Range:

- -65° F to +450° F (-54° C to +232° C)

Orifice Size:

- .187" (4.8mm)

C_v Factor:

- .60

Features:

- All wetted components constructed of high chrome, high nickel austenitic stainless steel for uniform chemical corrosion resistance including hydrogen sulfide
- 316 stainless steel body
- Lock pin secures packing nut for safety
- Dyna-Pak® packing below the stem threads prevents fluid from contacting stem threads
- 17-4PH stainless steel non-rotating stem tip for extended cycle life
- All valves tested for bubble-tight leakage at both seat and packing



Forged Body Needle Valves 2800 Series

Applications:

- High temperature service to 700° F
- Corrosives
- Reactive and hot condensates

Maximum Operating Pressure:

- 4000 psig @ 70° F
(276 barg @ 21° C)
- 2500 psig @ 700° F
(172 barg @ 370° C)

Maximum Operating Temperature:

- 700° F (371° C)

Orifice Size:

- .312" (7.9 mm)

C_v Factor:

- 1.10

Features:

- 316 stainless steel forged body
- Union bonnet design provides maximum reliability
- 17-4PH stainless steel non-rotating stem tip
- Grafoil® packing for high temperature service
- Stem backseat for added safety



Needle Valves



Forged Body Needle Valves 3700, 3800, 3900 Series

Applications:

- Instrument air lines
- Gas sampling lines
- Test stands

Maximum Operating Pressure:

- 5000 psig @ 70° F
(345 barg @ 21° C)

Operating Temperature Range:

- -65° F to +450° F (-54° C to +232° C)

Orifice Sizes:

- .060" to .312" (1.5 mm to 7.9 mm)

C_v Factors:

- .07 to 1.10

Features:

- Variety of materials—brass, 316 stainless steel, carbon steel
- Dyna-Pak® packing provides leak-tight seal and low operating torque
- Choice of PCTFE, regulating, Vee-point, or blunt stem tips
- Panel mounting possible without packing disruption
- Globe and angle patterns

Metering Valves



Milli-Mite® Forged Metering Valves 1300 Series

Applications:

- Fine metering for gas or vapor analysis
- Sampling and analyzing water and air pollution
- Chromatographs and mass spectrometers

Maximum Operating Pressure:

- 5000 psig @ 70° F
(345 barg @ 21° C)

Operating Temperature Range:

- -65° F to +450° F (-54° C to +232° C)

Orifice Sizes:

- .047" (1.19 mm)

C_v Factors:

- .010 (1° stem)
- .024 (3° stem)

Features:

- Choice of brass or 316 stainless steel
- Accurate metering and consistent reproducibility of flow settings
- Precision orifice and close thread tolerances eliminate hysteresis
- Micrometer vernier handle provides visual control and precise flow settings
- Dyna-Pak® packing below stem threads provides leak-tight service

Micro-Mite® Forged Metering Valves 1600 Series

Applications:

- Chromatography
- Mass spectroscopy
- Sampling and fine metering
- Pollution-analyzing instrumentation

Maximum Operating Pressure:

- 5000 psig @ 70° F
(345 barg @ 21° C)

Operating Temperature Range:

- -20° F to +250° F (-29° C to +121° C)

Orifice Sizes:

- .031" (.79mm)

C_v Factor:

- .0008

Features:

- Choice of brass or 316 stainless steel
- Low internal volume for accurate flow
- New dial indicator provides instant reading of stem position
- Non-rotating stem provides smooth flow pattern
- Ideal repeatability of flow settings
- O-ring seals below stem thread



Metering Valves

Bar Stock Metering Valves 2300 Series

Applications:

- Metering liquids and gases
- Laboratory sampling
- Gas chromatographs and analyzers

Maximum Operating Pressure:

- 3000 psig @ 70° F
(207 barg @ 21° C)

Operating Temperature Range:

- -60° F to +250° F (-51° C to +121° C)

Orifice Sizes:

- .062" (1.57 mm)
- .125" (3.17 mm)

C_v Factors:

- .012 (.062" orifice, 1° stem)
- .086 (.062" orifice, 8° stem)
- .30 (.125" orifice, 8° stem)

Features:

- Choice of brass or 316 stainless steel
- Spring-loaded stem prevents galling and possible orifice enlargement
- PCTFE seat allows positive shutoff
- 1° stem is available for fine metering
- Panel mounting is standard on all valves
- Optional micrometer handle



Ball Valves

2- and 3-Way 3-Piece Bolted Ball Valves 7 Series

Applications:

- Chemical processing
- Petroleum refining
- Gas distribution
- Sampling systems
- Hydraulic fluids
- Steam service
- Chlorine service

Operating Pressure Range:

- 2-Way
 - Vacuum to 2500 psig @ 70° F
(172 barg @ 21° C)
- 3-Way
 - Vacuum to 1500 psig @ 70° F
(103 barg @ 21° C)

Operating Temperature Range:

- -65° F to +500° F (-54° C to +260° C)

Orifice Sizes:

- 2-Way - 0.09" to 0.88"
(2.3 mm to 22.4 mm)
- 3-Way - 0.09" to 0.63"
(2.3 mm to 16.0 mm)

C_v Factors:

- 2-Way - 1.0 to 38
- 3-Way - 1.0 to 9

Features:

- Energized PTFE stem seal compensates for temperature and pressure with zero leakage to over 50,000 cycles
- Live-loaded seats provide zero leakage and long cycle life
- Safety—blowout-proof, grounded stem prevents static charge build-up
- Fully encapsulated bolts
- Enclosed seats and seal reduce cold flow and extend operating pressure range
- Remote actuation packages available

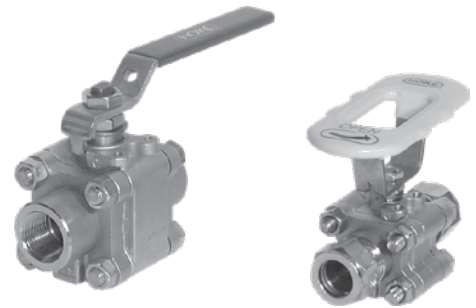

Ball Valves

Pneumatic Actuators for 7 Series Ball Valves

Operating Temperature Range:

- standard: -4° F to +194° F (-20° C to +90° C)
- optional high temperature model to +320° F (+160° C)

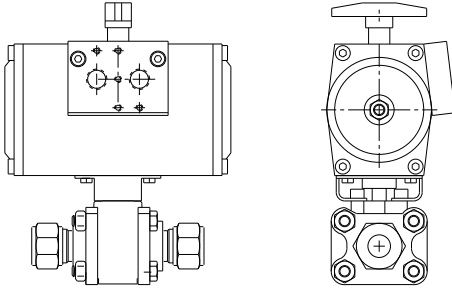

Features:

- Available in Double Acting (air to open and air to close) or Spring Return (normally open or normally closed) models.
- Durable construction stands up to harsh environmental conditions, increasing durability and reliability.
- Compact size provides greater installation flexibility in tight spaces.
- Field assembled valve / actuator option provides simple conversion of manual valve to pneumatic operation. This increases flexibility and decreases installation costs.
- Top mounted actuator allows for conversion from manual valve to pneumatic operation without disrupting packing. Ensuring leak-tightness and improving reliability.
- Long cycle life results in reduced maintenance requirements and lower cost of ownership.

High Cycle Ball Valves D, DL, T, TL Series

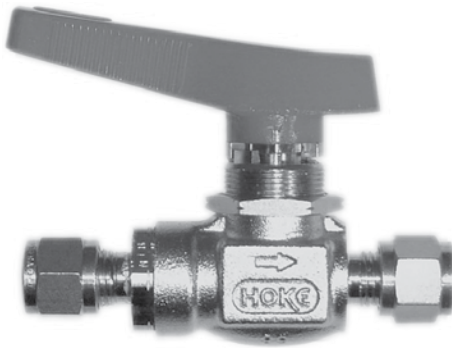

Applications:

- Instrumentation lines liquid or gas
- Pressure test stands high or low pressure
- Sampling systems

Maximum Operating Pressure:

- 316 SS and MONEL®:
 - D & DL Series: 6000 psig @ 70° F (414 barg @ 21° C)
 - T & TL Series: 3000 psig @ 70° F (207 barg @ 21° C)
- Brass:
 - D, DL, T, & TL Series: 3000 psig @ 70° F (414 barg @ 21° C)

Cycle Life:

D, T = 50,000; DL, TL = 100,000

Operating Temperature Range:

- -40° F to +350° F (-40° C to +177° C)

Orifice Sizes

- .093" – .250" (2.4 mm–6.4 mm)

C_v Factors

- .23–1.44

Features:

- Delta stem seal (DL) and spring-loaded PTFE seal (TL) provide high cycle life over 100,000 cycles.
- Live-loaded seats compensate for wear and temperature cycling with zero leakage.
- Static-grounded stem prevents static discharge for safety.
- Bi-directional (D & T)
- Uni-directional (DL & TL)
- Optional factory-assembled actuator ensures lower installed cost.

Ball Valves

Ultramite™ Forged Body Ball Valves 70 Series

Applications:

- High pressure test stands
- Sampling lines
- Instrument lines
- Analyzer labs

Maximum Operating Pressure:

- 6000 psig @ 70° F
(414 barg @ 21° C)

Operating Temperature Range:

- -40° F to +350° F (-40° C to +177° C)

Orifice Sizes:

- .093" to .375" (2.4 mm to 9.5 mm)

C_v Factors:

- .15 to 1.4

Features:

- Variety of materials—brass, 316 stainless steel, MONEL®
- Oval trip-proof handle gives visual flow indication
- Floating ball uses system pressure to assist sealing and reduce operating torque
- Fixed end fittings to prevent accidental disassembly



Flomite® 2-way Integral Panel Mount 71 Series

Applications:

- High pressure instrument lines
- Gas sampling lines
- Chromatographs
- Hydraulic test stands

Maximum Operating Pressure:

- 6000 psig @ 70° F
(414 barg @ 21° C)

Operating Temperature Range:

- -20° F to +425° F (-29° C to +218° C)

Orifice Sizes:

- .093" to .250" (2.4 mm to 6.4 mm)

C_v Factors:

- .23 to 1.40

Features:

- Variety of materials brass, 316 stainless steel, MONEL®
- Floating ball uses system pressure to assist sealing and reduce operating torque
- Dyna-Pak® packing provides long, trouble-free service and low operating torque
- Quarter-turn handle gives visual flow indication
- Forged body for extra strength
- Dual seats provide leak-tight bi-directional sealing



Selectomite® 3-Way Ball Valves 71 and 76 Series

Applications:

- Instrument air lines
- Sampling systems

Maximum Operating Pressure:

- 6000 psig @ 70° F
(414 barg @ 21° C)

Operating Temperature Range:

- -40° F to +350° F (-40° C to +177° C)

Orifice Sizes:

- .093" to .187" (2.4 mm to 4.8 mm)

C_v Factors:

- .15 to .57

Features:

- Choice of brass or 316 stainless steel
- Dyna-Pak® packing provides trouble-free service and low operating torque
- Encapsulated TFE or Nylatron® seats eliminate cold flow and distortion
- Handle indicates flow direction



Ball Valves

Rotoball® 2-Way Ball Valves 72 Series



Applications:

- Hydraulic test stands
- Handling slurries
- Pilot plants
- Pneumatic systems

Maximum Operating Pressure:

- 5000 psig @ 70° F
(345 barg @ 21° C)

Operating Temperature Range:

- -20° F to +350° F (-29° C to +177° C)

Orifice Size:

- .375" (9.5 mm)

C_v Factor:

- 3.4

Features:

- Choice of brass, 316 stainless steel, or MONEL®
- Choice of Viton® O-rings or TFE washers for improved corrosive / temperature compatibility
- Encapsulated TFE seats eliminate cold flow and distortion
- Dual seats provide leak-tight bi-directional flow
- Nylon oval handle or optional metal lever handle
- Blowout-proof stem

Space Saver® Air Actuators 0700 Series

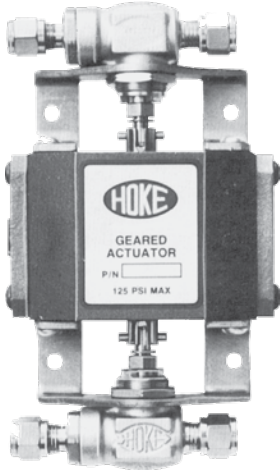

Applications:

- Compact interlocking of multiple actuators
- Ideal for instrumentation panels
- Actuates small and mid-sized ball valves

Maximum Operating Pressure:

- 125 psig @ 70° F (9 barg @ 21° C)

Operating Temperature Range:

- 0° F to +400° F (-18° C to +204° C)

Features:

- Small envelope (2¼" × 2¾" × 3½")
- Can actuate two valves simultaneously
- Multiple mounting options
- Uses standard shop air
- Available in spring return and double acting modes
- 90° and 180° operation

Electrically Operated Air Actuators 0100 Series



Applications:

- Automated instrument and process systems
- Test areas
- Corrosive atmospheres

Voltage:

- AC – 115 VAC/60 cycles
- DC – 24 VDC

Rated Current:

- AC – 1.6 amps
- DC – .63 amps

Cycle Time:

- AC/DC – 2.5 seconds per 90° of travel

Power Consumption:

- AC – 57 watts
- DC – 15 watts

Features:

- Position indicator switches are standard
- Compact design for small-space installation
- Weatherproof enclosures
- Thermal overload relay prevents motor burnout
- Manual override allows for manual valve operation

Ball Valves

Multimite® 4- and 5-Way Trunnion Valves 79 Series

Applications:

- Distribution systems
- Manifold switching
- Sampling systems

Maximum Operating Pressure:

- 6000 psig @ 70° F
(414 barg @ 21° C)

Operating Temperature Range:

- 0° F to +350° F (-18° C to +179° C)

Orifice Sizes:

- .166" and .187" (4.2 mm and 4.8 mm)

C_v Factors:

- .47 to .66

Features:

- Corrosion-resistant 316 stainless steel
- Trunnion bearings eliminate galling
- Blowout-proof stem
- Spring-loaded ball engages every 90° to indicate full port position
- Choice of PTFE or Nylatron® seats



Plug Valves

Quarter-Turn Plug Valves 7300 Series

Applications:

- Instrument air lines
- Test benches
- Sampling lines
- Pilot plant instrumentation
- Low pressure air lines

Maximum Operating Pressure:

- 3000 psig @ 70° F
(207 barg @ 21° C)

Operating Temperature Range:

- -20° F to +400° F (-29° C to +204° C)

Orifice Sizes:

- .093" to .187" (2.4 mm to 4.8 mm)

C_v Factor:

- .74

Features:

- Choice of brass or 316 stainless steel
- Oval trip-proof handle provides visual flow indication
- Dual retaining rings prevent accidental plug removal
- Throttling capabilities
- Vented version for down stream venting
- Retainer allows 1000 psig (69 barg) reverse operating pressure



Rising Stem Plug Valve: 7400 Series

Applications:

- Lines containing small solid impurities
- Instrumentation lines containing viscous fluids or slurries
- Systems requiring routine cleaning
- Systems requiring flow regulation and full flow capabilities

Maximum Operating Pressure:

- 6000 psig @ 70° F
(414 barg @ 21° C)

Operating Temperature Range:

- -20° F to +250° F (-29° C to +121° C)

Orifice Sizes:

- .187" and .250" (4.7 mm and 6.3 mm)

C_v Factors:

- .83 and 1.20

End Connections:

- ¼" to ½" NPT

Features:

- Back seating is standard
- High C_v and rodability
- Flow regulation similar to that of a needle valve
- Helps reduce fugitive emissions
- Extended valve life
- Replaceable seat



Fluid Control Components

Forged Body Toggle Valves 1500 Series



Applications:

- Chromatographs and mass spectrometers
- Test benches
- Coolant lines

Maximum Operating Pressure:

- 200 psig @ 70° F
(14 barg @ 21° C)

Operating Temperature Range:

- -20° F to +300° F (-29° C to +149° C)

Orifice Sizes:

- .125" to .219" (3.2 mm to 5.6 mm)

C_v Factors:

- .23 to .60

Features:

- Brass or 316 stainless steel
- Elastomeric seals for vacuum service
- Toggle handle provides instant on-off control
- Compact design

Relief Valves R6000 Series



Applications:

- Beverage dispensing equipment
- Gas pilot plants
- Petrochemical test labs
- Offshore platform heating lines
- Pharmaceutical sterilization and packaging systems

Maximum Operating Pressure:

- 5 psig to 6000 psig (0-414 barg)

Operating Temperature Range:

- -70° to +550° F (-57° to +288° C)

Orifice Sizes:

- 0.082", 0.094", 0.188" (2.1 mm, 2.4 mm, 4.8 mm)

Relief Ranges ΔP:

- 5 - 550 psig (0 - 38 barg)
- 150 - 2500 psig (10 - 172 barg)
- 150 - 5000 (10 - 345 barg)
- 5000 - 6000 psig (345 - 414 barg)

Features:

- 316 stainless steel body
- Narrow pressure ranges can be factory pre-set
- Can be used with any liquid or gas service
- Caps and bonnets are pre-drilled for lock wire
- PED certification and CE marking standard for all models

Ball and Poppet Check Valves 6100 & 6200 Series



Applications:

- Prevention of reversed flow
- Locking pressure in hydraulic cylinders
- Vent valve to purge system

Maximum Operating Pressure:

- 6000 psig @ 70° F
(414 barg @ 21° C)

Operating Temperature Range:

- -40° F to +350° F
(-40° C to +177° C)

Cracking Pressures:

- 1/3, 2, 10 and 25 psig (.02, .14, .69 and 1.7 barg)

Orifice Sizes:

- .187" and .422" (4.8 mm and 10.7 mm)

C_v Factors:

- .3 and 2.4

Features:

- Variety of materials—brass, 316 stainless steel, MONEL®
- Ball and poppet designs are standard
- Poppet models provide large flow with minimum chatter and fluctuation
- Ball models provide fast open-close response
- O-ring seat provides leak-tight shut-off

Fluid Control Components

Check Valves CVH Series

Applications:

- Back pressure protection
- Prevents reverse flow
- Protection of solenoids, analyzers, regulators, etc.

Maximum Operating Pressure:

- 0 to 6000 psig (0 to 414 barg)

Operating Temperature Range:

- -65° F to +550° F
(-54° C to +288° C)

End Connection Sizes:

- 1/8" to 1", 6 mm to 25 mm

Crack Pressures:

- .5 to 20 psig (.03 to 1.4 barg)

C_v Factors:

- .32 to 7.4

Features:

- Resilient O-ring seat provides cushioned quiet closing and zero leakage
- Floating O-ring is continually cleaned: contaminants do not prohibit sealing
- Various materials of construction: can be used with any liquid or gas service
- Full flow with minimal restriction for maximum C_v rates



Excess Flow Valve: XVH Series

Applications:

- Gas delivery systems
- Analyzer sample lines
- Cabinet purge gas systems
- Differential pressure cell lines

Maximum Operating Pressure:

- Zero to 6000 psig (414 barg)

Operating Temperature Range:

- -320° F to +900° F
(-196° C to +482° C)

End Connection Sizes:

- 1/4", 3/8", 1/2", 6 mm through 14 mm

Features:

- Flow switches that automatically close if a flow spike occurs, preventing uncontrolled release of system fluid
- Automatic and manual reset poppets
- Can be used with any liquid or gas service
- Anti-clog wire prevents clogging of bleed port



Inline -, Removable- and Bypass Micron Filters 6300 Series

Applications:

- Trapping of foreign particles
- Protection of sensitive equipment
- System purging
- Pressure Damping

Maximum Operating Pressure:

- Brass
 - 3000 psig @ 70° F
(207 barg @ 21° C)
- Stainless steel
 - 5000 psig @ 70° F
(345 barg @ 21° C)

Operating Temperature Range:

- -60° F to +450° F (-51° C to +232° C)

Filtering Range:

- 2 to 55 microns

C_v Factors:

- .006 to .420

Features:

- Choice of brass or 316 stainless steel bodies
- 316 stainless steel elements
- Choice 6310 inline, 6320 removable, or 6330 bypass series
- Bypass models permit purging and sampling of process fluid



6310 Inline Series



6330 Bypass Series (6320 is similar, except no outlet on top)

Packless Valves



Air Actuated Bellows Valves 0300 Series

Applications:

- High purity
- Diffusion furnaces
- Gas panels

Operating Pressure Ranges:

- Actuator: 50 to 150 psig @ 70° F (3.4 to 10.3 barg @ 21° C)
- Valve: vacuum to 350 psig (24 bar – Normally Open)
- Valve: vacuum to 200 psig (14 bar – Normally Closed)

Operating Temperature Range:

- -40° F to +250° F (-40° C to +121° C)

Orifice Size:

- .170" (4.3 mm)

C_v Factor:

- .28

Internal Volume:

- .08 cubic inches (1.3 cc)

Features:

- Compact design for small-space installations
- Valve body made of corrosion-resistant 316 stainless steel
- Actuator body made of lightweight aluminum
- Choice of Normally Open or Normally Closed models
- Replaceable PCTFE seat extends valve life



Bellows Sealed Valves 4100 Series

Applications:

- Critical gas analysis
- Reactive and toxic fluids
- Vacuum systems bake-out

Maximum Operating Pressure:

- High vacuum (10⁻⁵ torr) to 1000 psig @ 600° F (69 barg @ 316° C)

Operating Temperature Range:

- -40° F to +600° F (-40° C to +316° C)

Orifice Sizes:

- .059" and .170" (1.5 mm and 4.3 mm)

C_v Factors:

- .06 and .35

Internal Volume:

- .08 cubic inches (1.3 cc)

Features:

- Choice of brass or 316 stainless steel
- Choice of blunt, Vee-point, or PCTFE tips
- Removable nylon handle for high temperature bake-out
- Bellows silver-soldered to body



Bellows Sealed Valves 4200 Series

Applications:

- Critical gas analysis
- Reactive and toxic fluids
- Cryogenics
- High vacuum systems

Maximum Operating Pressure:

- High vacuum (10⁻⁵ torr) to 2000 psig @ 600° F (138 barg @ 316° C)

Operating Temperature Range:

- -320° F to +1200° F (-195° C to +649° C)

Orifice Size:

- .156" (4.0 mm)

C_v Factors:

- .33 and .36

Internal Volume:

- .18 cubic inches (3.0 cc)

Features:

- Corrosion-resistant 316 stainless steel
- Positive plug return prevents plug from sticking
- Torque not transmitted to bellows
- Secondary seal in upper bonnet for added protection
- Heavy-duty bellows for long life

Packless Valves

Bellows Sealed Valves 4500 Series

Applications:

- High vacuum systems
- Laboratories
- Critical gas analysis

Maximum Operating Pressure:

- High vacuum (10^{-5} torr) to 300 psig @ 250° F (21 barg @ 121° C)

Operating Temperature Range:

- -20° F to +250° F (-29° C to +121° C)

Orifice Sizes:

- .156" and .281" (4 mm and 7.1 mm)

C_v Factor:

- .70

Internal Volume:

- .08 cubic inches (1.3 cc)

Features:

- Choice of brass or MONEL®
- Protective handle limits escape of process fluid in case bellows ruptures
- Encapsulated PCTFE seat
- Bellows is sealed to body with PCTFE gasket
- Bellows assembly is easily replaced



Diaphragm Valves 4600 Series

Applications:

- High temperature bake-out systems
- High vacuum systems

Maximum Operating Pressure:

- High vacuum (10^{-5} torr) to 300 psig @ 70° F (21 barg @ 21° C)

Operating Temperature Range:

- -65° F to 600° F (-54° C to +316° C)

Orifice Size:

- .125" (3.2 mm)

C_v Factor:

- .2

Internal Volume:

- .11 cubic inches (1.8 cc)

Features:

- MONEL® construction
- Diaphragm provides low internal volume and low dead space
- Compact size for small-space installations
- Gasket and welded models



2-Way Diaphragm Valves DV1 Series

Applications:

- Analytical Instrumentation
- Petrochemical
- Pharmaceutical
- Chemical

Maximum Operating Pressure:

- Vacuum (50 torr) to 3600 psig (248 barg)

Operating Temperature Range:

- -40° F to +400° F (-40° C to +204° C)

Orifice Size:

- .110" (2.8 mm)

C_v Factors:

- 0.17

Low Valve Internal Volume:

- 0.16 cc

Features:

- Totally free of springs, bellows, packing, O-rings and lubricants in process wetted area
- Metal-to-metal seals to atmosphere: no leaching of undesirable elements into the flow stream
- Elgiloy® diaphragms insure the utmost in corrosion resistance and life span



Manifolds

General Purpose Manifolds



Instrument Manifolds 2-, 3-, 5-Valve

Application:

- Differential pressure transmitters
- Chemical
- Pharmaceutical
- Petrochemical

Operating Temperature Range:

- PTFE: -0° F to +392° F (-18° C to +200° C)
- Grafoil®: -0° F to +842° F (-18° C to +450° C)

Maximum Operating Pressures:

- PTFE packing:
6000 psig @ 212°F (414 barg @ 100°C)
- Grafoil® packing:
6000 psig @ 212°F (414 barg @ 100°C)
3300 psig @ 842°F (288 barg @ 450°C)

Features:

- Remote (or pipe) mounting can be independently mounted
- Direct (or flange) mounted manifolds reduces the number of connections and possible leak points
- 2, 3, or 5 valve manifolds offer various levels of process control & measurement
- Backseat stem
- One-piece non-rotating stem tip minimizes seat galling

Special Application Manifolds

Trifold™ Needle Valve Manifold

Application:

- Differential pressure transmitters with 2.125 inch center to center process connections.

Maximum Operating Pressure:

- 6000 psig @ 70° F (414 barg @ 21° C)

Operating Temperature Range:

- -65° F to +600° F (-54° C to +316° C)

Features:

- Purge ports provided on process side of block valves for applications requiring continuous purging
- Dyna-Pak TFE or high-temperature 600° F Graph-Lock /TFE wafer packing is standard.
- Non-rotating hardened metal stem tip
- Replaceable 316 stainless steel seats prolong manifold life
- Dyna-Pak® PTFE wafer or high temperature graphite / PTFE packing
- Choose pipe or flange outlet models

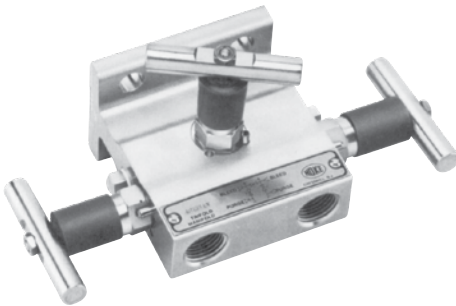

Rotofold® Ball Valve Manifold

Application:

- Block process impulse lines and perform equalizing functions

Maximum Operating Pressure:

- 6000 psig @ 70° F (414 barg @ 21° C)

Operating Temperature Range:

- 0° F to 300° F (-18° C to +149° C)

Features:

- Flange can be reversed for direct mounting to an integral orifice type transmitter
- Replaceable PCTFE seats extend valve life
- Rod through block valves
- Quarter-turn handle gives visual flow indication
- Cam handles ensure proper valve sequencing



Special Applications Manifolds

Pentafold® 5-Valve Manifold

Application:

- Differential pressure transmitters when applied to gas flow measurement

Maximum Operating Pressure:

- 6000 psig @ 70° F
(414 barg @ 21° C)

Operating Temperature Range:

- 0° F to 300° F (-18° C to +149° C)

Features:

- Static or vent ports provided on instrument side
- Replaceable ball seats and stem tips extend service life, reducing cost
- Threaded mounting hole provide on all models
- TFE standard packing on all valves



Sampling Cylinders

Spun Sampling Cylinders

Applications:

- Hydrocarbon sampling
- High vacuum systems
- Chemical reaction vessels

Maximum Operating Pressure:

- 1800 psig (124 barg)

Features:

- Choice of 7 capacities ranging from 75 cc to 3785 cc (1 gallon)
- Manufactured to DOT 3A or 3E requirements
- All interior surfaces are sandblasted for a uniform surface
- 316 Stainless Steel construction



Formed Sampling Cylinders

Applications:

- Hydrocarbon sampling
- Gas sampling
- Snubbers in reactor feed lines

Maximum Operating Pressure:

- 5000 psig @ 70° F
(345 barg @ 21° C)

Features:

- Choice of 12 different capacities, 10 ml to 4 gallons
- Fabricated from seamless drawn tubing with increased thickness in the threaded area
- All models are internally sand-blasted
- Single- and double-ended cylinders are standard
- Variety of materials—304 stainless steel, MONEL®, and various exotics available upon request

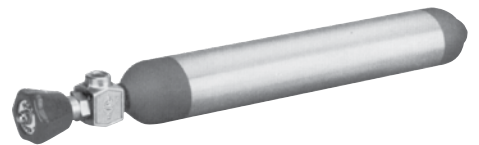

Sampling Cylinders



Safety Relief Devices: 6700 Series

Application:

- Over-pressure protection for HOKE® sampling cylinders

BURSTING DISK MODELS

Operating Pressure Ranges:

- 1400 to 1600 psig @ 70° F (97 to 110 barg @ 21° C)
- 1800 to 2000 psig @ 70° F (124 to 138 barg @ 21° C)
- 2600 to 3000 psig @ 70° F (179 to 207 barg @ 21° C)
- 3500 to 4100 psig @ 70° F (241 to 283 barg @ 21° C)
- 5400 to 6200 psig @ 70° F (372 to 428 barg @ 21° C)

SPRING RELIEF MODELS

Operating Pressure Ranges:

- 350 to 400 psig @ 70° F (24 to 28 barg @ 21° C)
- 540 to 600 psig @ 70° F (37 to 41 barg @ 21° C)

Operating Temperature Range (Both Models):

- -20° F to +250° F (-29° C to +121° C)

Features:

- Spring relief models reseal after venting excess pressure
- INCONEL® rupture discs and 316 stainless steel body for increased corrosion resistance
- Color-coded discs meet requirements of CGA-S1.1

Analytical Products



73S Series Selector Valves

Applications:

- Process analyzers
- Instrumentation
- Gas chromatography

Maximum Operating Pressure:

- 500 psig @ 70° F (34.5 barg @ 21° C)
- 200 psig @ 350° F (13.8 barg @ 175° C)

Operating Temperature Range:

- -40° F to +350° F (-40° C to +177° C)

Orifice Sizes:

- .051" to .093" (1.30 mm – 2.36 mm)

C_v Factor:

- .071 maximum

Features:

- 5-way or 7-way configuration
- Wide temperature range
- Sliding seal principles
- Bi-directional flow
- GYROLOK® Tube Fitting or female NPT connections

Chromatography Fittings



Applications:

- Gas or liquid chromatography
- Analytical equipment

Maximum Operating Pressure:

- Rated for working pressures higher than the tubing recommended for use

Operating Temperature Range:

- -325° F to +800° F (-198° C to +427° C)

Orifice Sizes:

- .013" - .052" (0.33 mm – 1.32 mm)

Features:

- Low dead volume
- Controlled ferrule drive
- Interchangeability
- Press-fit or drop-in frits

GYROLOK® Features and Benefits

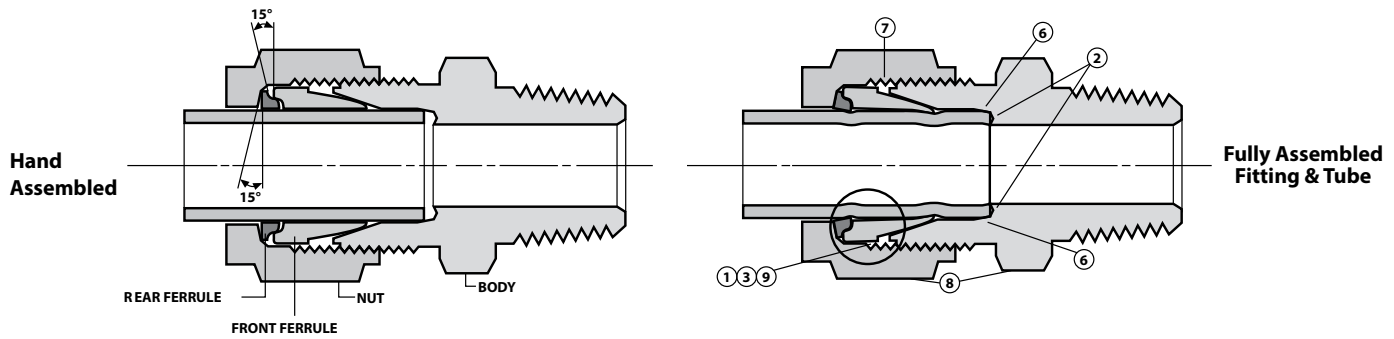

FEATURES	EXPLANATION	BENEFITS
1. CONTROLLED FERRULE DRIVE	Roll-in locking action of rear ferrule: During fitting makeup, 15° angles close — between the rear ferrule and nut, and between the rear ferrule and front ferrule — thus preventing overstressing of tubing or excessively reducing tubing inside diameter. Front ferrule shoulder: Front ferrule shoulder prevents body expansion and nut jamming, caused by over-tightening.	Provides maximum user safety under high pressure/vibration conditions. Prevents overstressing, which causes tubing failure and possible injury. System efficiency is improved by maximizing flow. Provides unmatched remake life. Maximizes value and economy.
2. BUTT SEAL	Provides a secondary seal and eliminates dead space.	Maximizes fitting leak integrity and user safety. Can seal with scratched tubing. Increases accuracy in sampling applications. Reduces pump-down time in vacuum applications.
3. HOKE® VALVES WITH GYROLOK® END FITTINGS	Controlled ferrule drive prevents end connection expansion, thus prolonging valve life and eliminating the need to use female-ended valves with separate fittings. Eliminates a possible leak path and extends valve life.	Long product life and maximum value. Safety and economy.
4. GYROLOK® SAFETY CHANGER NUT AND FERRULE SETS	Nut and ferrule sets supplied on rods, already correctly oriented. (Not necessary to handle ferrules when replacing components.)	Safest, simplest device for component replacement.
5. GYROGAGE	Marks tubing to show that tubing has been properly inserted into fitting, and that fitting has been properly tightened.	Maximum safety resulting from ability to verify correct tube insertion and proper tightening.
6. SIZING ANGLE	Slight taper in the base of the tube socket reduces possibility of tube sticking	Less tube sticking during disassembly saves time and money
7. SILVER-PLATED NUT THREADS	Silver-plating extends fitting life by preventing galling, up to 1200° F (649° C).	Extended product life at extreme temperatures.
8. MATERIAL TRACEABILITY ON FITTING BODY AND NUT	Bodies and nuts made of 316 Stainless Steel and MONEL® are heat code traceable to Certified Material Test Reports.	Traceability provides added safety. Certified Material Test Reports are available for review and verification.
9. PFA FERRULE COATING	Front ferrules—Sizes larger than 1" (25mm) are PFA coated.	Increased resistance to media and atmospheric corrosion.
10. SPECIAL HIGH TOLERANCE NPT THREAD	ANSI Standard B1.20.1 - Basic + ¼ to Basic +1.	Provides a Safer more robust connection: 63% tighter tolerance with up to six thread engagement, reduced galling and vibration

GYROLOK®

General Information

The GYROLOK® Design

GYROLOK® Tube Fittings have been carefully designed and manufactured to provide a wide range of outstanding leak-tight application capabilities.

Materials:

GYROLOK® fittings are available as standard in brass, 304 stainless steel, 316 stainless steel and MONEL®:

316 Stainless Steel Forgings: ASTM A-182
 Brass Bar Stock, Alloy 360: ASTM B-16
 316 Stainless Steel Bar Stock: ASTM A-479
 MONEL® Forgings, Alloy 400: QQ-N-281
 Brass Forgings, Alloy 377: QQ-B-626
 MONEL® Bar Stock, Alloy 405: QQ-N-281
 Brass Bar Stock, Alloy 353: ASTM B-453
 MONEL® Bar Stock, Alloy K500: QQ-N-286

HOKE® fittings are also available for custom orders in special shapes and special materials:

HASTELLOY® C-276: HC
 INCONEL®: INC
 Titanium: TI
 Duplex 2205: DX3
 Super Duplex 2507: D50
 254 SMO: 6MO

Contact your local HOKE® Distributor for further information.

Certified Material Test Reports (CMTRs):

Bodies and nuts of GYROLOK® fittings in all materials other than brass are heat code traceable. To obtain CMTRs for these components, place separate orders for such items and specify "CMTRs required on all items".

Pressure Rating:

GYROLOK® fitting ends⁽¹⁾ are rated for working pressures **higher** than the tubing recommended for use with GYROLOK®.

⁽¹⁾ Note: Pressure ratings may vary for other fitting ends.

Tubing should not be utilized at pressures above its maximum allowable working pressure. Check the HOKE® Tubing Data Charts for specific information. If no pressure is identified for a given size and wall thickness of tubing, that tubing is not considered suitable for the use with tube fittings.

Vacuum Rating:

GYROLOK® offers deep vacuum capability. With good quality tubing, GYROLOK® fittings will be leak-tight at vacuum levels of 10⁻⁹ torr while tested with a leakage sensitivity of 10⁻⁹ sccs.

CAUTION: (For stainless steel) Intermittent use to 1200° F (649° C) is possible, however, prolonged exposure to temperatures over 800° F (427° C) is not recommended.

Temperature:

GYROLOK® fittings provide safe, reliable performance from cryogenic temperatures to high temperature bake-out levels, depending on material.

- 316 stainless steel: -325° F to +800° F (-198° C to +427° C)
- Brass (copper tubing): -325° F to +400° F (-198° C to +204° C)
- MONEL®: -325° F to +800° F (-198° C to +427° C)

Pipe Thread Information

GYROLOK® tube fittings are available with NPT (National Pipe Taper), BSP/ISO (British Standard Pipe / International Standards Organization) or unified screw threads.

Straight or Parallel Threads

Specification(s)	Type	Part Number or Suffix Designation	Sealing Method
American Standard unified screw threads	Male	Fitting type ends in S, as in COS or AOS	Generally utilizes an elastomer O-ring to provide sealing
RP to ISO 228/1 BS 2779 JIS B0202	Male	Modifier is B, following the unit of measure for fractional (E) or metric (M), as in 6CM4316EB	Metal-to-metal sealing to DIN 3852, Form B
RS to ISO 228/1 BS 2779 JIS B0202	Male	Modifier is A, following the unit of measure for fractional (E) or metric (M), as in 6CM4316EA	Utilizes a sealing washer to provide sealing. Reference DIN 3852, Form A **
RG to ISO 228/1 BS 2779 JIS B0202	Female	Modifier is Z, following the unit of measure for fractional (E) or metric (M), as in 6CF4316EZ	Sealing form meets DIN 3852, Form Z

** Female RP or RS ends available with Form X.

Tapered Thread Information

Specification(s)	Type	Part Number or Suffix Designation	Sealing Method
NPT	M/F	Fitting type ends in M or F, as in CM or CF	Seal is made on the thread. Thread sealant is required.
RT to ISO 7/1 BS 21 JIS B0203 DIN 2999	M/F M/F M/F Male	Modifier is C, following the unit of measure for fractional (E) or metric (M), as in 6CM4316EC	Seal is made on the thread. Thread sealant is required. The BSP/ISO thread utilizes a different angle and the number of threads per inch may differ from NPT. Reference DIN 3852, form C.

GYROLOK® Tube Fittings at a Glance

Fittings

Male Connector **CM** 

Male Thermocouple Connector **CMT** 

Female Connector **CF** 

Union **U** 

Reducing Union **RU** 

Reducer **R** 

Male Adapter **AM** 

Female Adapter **AF** 

Port Connector and Reducing Port Connector **PC** 

Bulkhead Adapter **BA** 

Male Bulkhead Connector **BCM** 

Female Bulkhead Connector **BCF** 

Bulkhead Union **BU** 

Male Elbow **LM** 

Female Elbow **LF** 

Union Elbow **LU** 

Male Run Tee **TMT** 

Male Branch Tee **TTM** 

Female Run Tee **TFT** 

Female Branch Tee **TTF** 

Union Tee **TTT** 

Heat Exchanger Tee **XT** 

Union Cross **C** 

Cap **CP** 

Plug **P** 

Tube Insert **TI** 

Lapped Flange Connector **CLF** 

Pre-setting Tool **PST** 

Fittings with O-ring Seals

O-ring Male Connector **COM** 

O-ring Straight Connector **COS** 

GYROLOK® Tube Fittings at a Glance

O-ring Male Adapter	AOM	
---------------------	------------	---

O-ring Straight Adapter	AOS	
-------------------------	------------	---

Fittings with Weld Ends

Socket Weld Connector	CW	
-----------------------	-----------	---

Butt Weld Connector	CBW	
---------------------	------------	---

Socket Weld Elbow	LW	
-------------------	-----------	---

Butt Weld Elbow	LBW	
-----------------	------------	--

Fittings with AN Ends

AN Union	UAN	
----------	------------	---

O-ring AN Union	UANO	
-----------------	-------------	---

Bulkhead AN Union	BUAN	
-------------------	-------------	---

AN Adapter	AAN	
------------	------------	---

Fittings with BSP/ISO Threads

Male Connector with RP Ends	CM/EB	
-----------------------------	--------------	---

Male Connector with RS Ends	CM/EA	
-----------------------------	--------------	---

Male Connector with RT Ends	CM/EC	
-----------------------------	--------------	---

Female Connector with RG Ends	CF/EZ	
-------------------------------	--------------	---

Female Connector with RT Ends	CF/EC	
-------------------------------	--------------	---

Male Adapter with RS Ends	AM/EA	
---------------------------	--------------	---

Male Adapter with RT Ends	AM/EC	
---------------------------	--------------	---

Female Adapter with RG Ends	AF/EZ	
-----------------------------	--------------	---

Female Adapter with RT Ends	AF/EC	
-----------------------------	--------------	---

Male Elbow with RT Ends	LM/EC	
-------------------------	--------------	--

Spare Parts

Nut	N	
-----	----------	---

Bulkhead Nut	BN	
--------------	-----------	---

Knurled Nut	KN	
-------------	-----------	---

Front Ferrule	FF	
---------------	-----------	---

Rear Ferrule	FR	
--------------	-----------	---

Screen	SCRN	
--------	-------------	---

Safety Changer Ferrule Sets	SCF	
-----------------------------	------------	---

Safety Changer Nut and Ferrule Sets	SCNF	
-------------------------------------	-------------	---

Precision Instrument Pipe Fitting

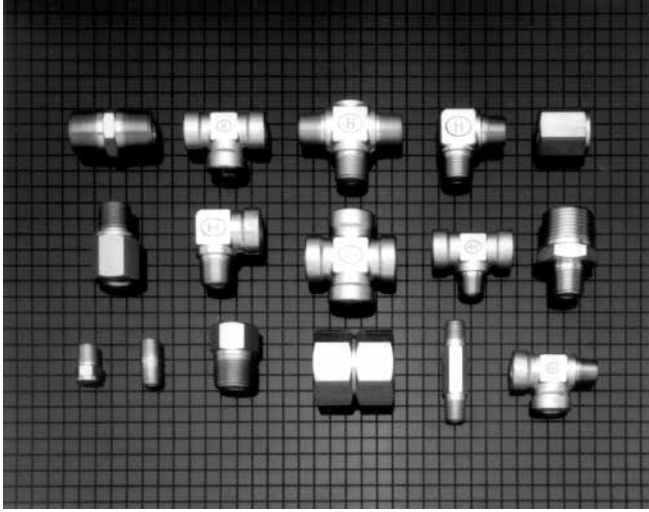

Design:

HOKE® Precision Instrument Pipe Fittings are machined from bar stock or forgings in brass or heat traceable 316 stainless steel. The fitting design incorporates an NPT thread as standard and meets the requirements of ANSI B 31.1 Power Piping Code, ANSI B 31.1 Chemical Plant and Petroleum Refinery Piping, and Section VIII of ASME Boiler & Pressure Vessel Code.

Available sizes include 1/8", 1/4", 3/8", 1/2", 3/4" and 1" threads, which exceed the requirements of ANSI B 1.20.1 for (NPT) tapered pipe threads. Protective end caps prevent damage to exposed threads.

Adapters, bushings, caps, couplings, crosses, elbows, nipples, plugs and tees are designed to fit most applications.

Materials:

HOKE® Precision Instrument Pipe Fittings are available as standard in brass and 316 stainless steel.

- | | |
|----------------------------------|------------|
| • 316 stainless steel Forgings: | ASTM A-182 |
| • 316 stainless steel Bar Stock: | ASTM A-479 |
| • Brass Forgings, Alloy 377: | QQ-B-626 |
| • Brass Bar Stock, Alloy 353 | ASTM B-453 |
| • Brass Bar Stock, Alloy 360: | ASTM B-16 |

Features:

- Fitting design meets the requirements of ANSI B 31.1 Power Piping Code, ANSI B 31.1 Chemical Plant and Petroleum Refinery Piping, and Section VII of ASME Boiler and Pressure Vessel Code.
- Fittings are machined from materials, which meet ASTM specifications.
- 316 stainless steel fittings are heat traceable.
- Available in wide variety of shapes and sizes.
- Threads exceed the requirements of ANSI B 1.20.1 for tapered pipe threads (NPT).
- Protective end caps prevent damage to exposed threads.

The following are trademarks of their respective companies: MONEL® and INCONEL®, Special Metals Corporation; HASTELLOY®, Haynes International, Inc.; Viton®, E.I. DuPont. GYROLOK® is a registered trademark of HOKE®.



The Small Bore Instrumentation Specialists



We specialize in small bore instrumentation products up to 2" that deliver benchmark performance quality & safety; provide the broadest array of superior alloy offerings in the market; decades of proven success in a wide range of industries; a roster of "who's who" customers & projects globally; original "Best Solution" engineering & designs; and are focused on continuous improvement in all aspects of our business.

Proudly Distributed By:



CRANE INSTRUMENTATION &
SAMPLING Inc.
405 Centura Ct.
Spartanburg, SC 29305, USA
Tel: 1-864-574-7966
PO Box 4866, Spartanburg, SC
29305-4866 USA

Crane Co., and its subsidiaries cannot accept responsibility for possible errors in catalogues, brochures, other printed materials, and website information. Crane Co. reserves the right to alter its products without notice, including products already on order provided that such alteration can be made without changes being necessary in specifications already agreed. All trademarks in this material are the property of the Crane Co. or its subsidiaries. The Crane and Crane brands logotype (CENTER LINE®, COMPAC-NOZ®, CRANE®, DEPA® & ELRO®, DOPAK®, DUO-CHEM®, FLOWSEAL®, GYROLOM®, GO REGULATOR®, HOKE®, JENKINS®, KROMBACH®, NOZ-CHEM®, PACIFIC VALVES®, RESISTOFLEX®, REVO®, SALUNDERS®, STOCKHAM®, TEXAS SAMPLING®, TRIANGLE®, UNI-CHEM®, VALVES®, WTA®, and XOMOX®) are registered trademarks of Crane Co. All rights reserved.